

MATADOR®

EXPLORER
E222
5+



- 3x
- 1x
- 2x

- 1x
- 1x
- 2x
- 2x

- 1x
- 2x
- 2x
- 1x
- 2x
- 2x

- 1x
- 1x
- 2x
- 2x
- 2x
- 2x

- 20x
- 20x
- 30x
- 30x
- 20x
- 20x

- 4x
- 4x
- 4x
- 4x
- 4x

- 6x
- 2x
- 10x
- 6x
- 4x
- 1x

001

LEVEL

5+

x 2

1 min

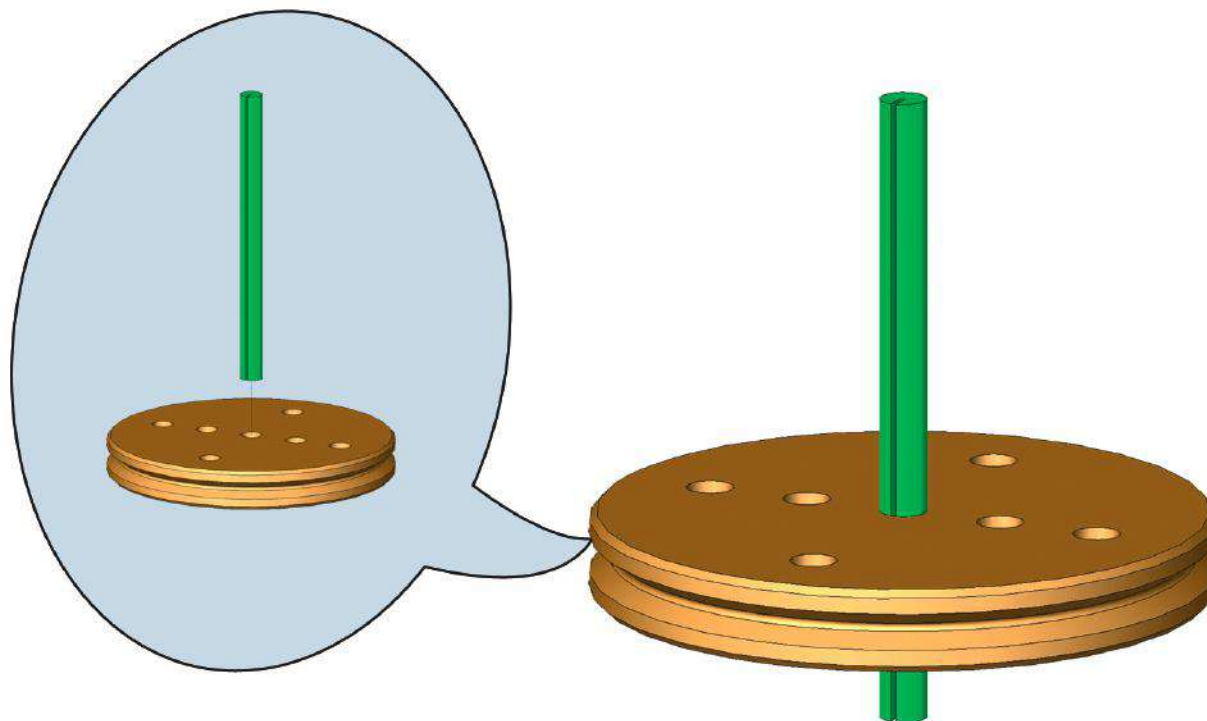

1x 

1x 

002

LEVEL

5+

x 5

2 min

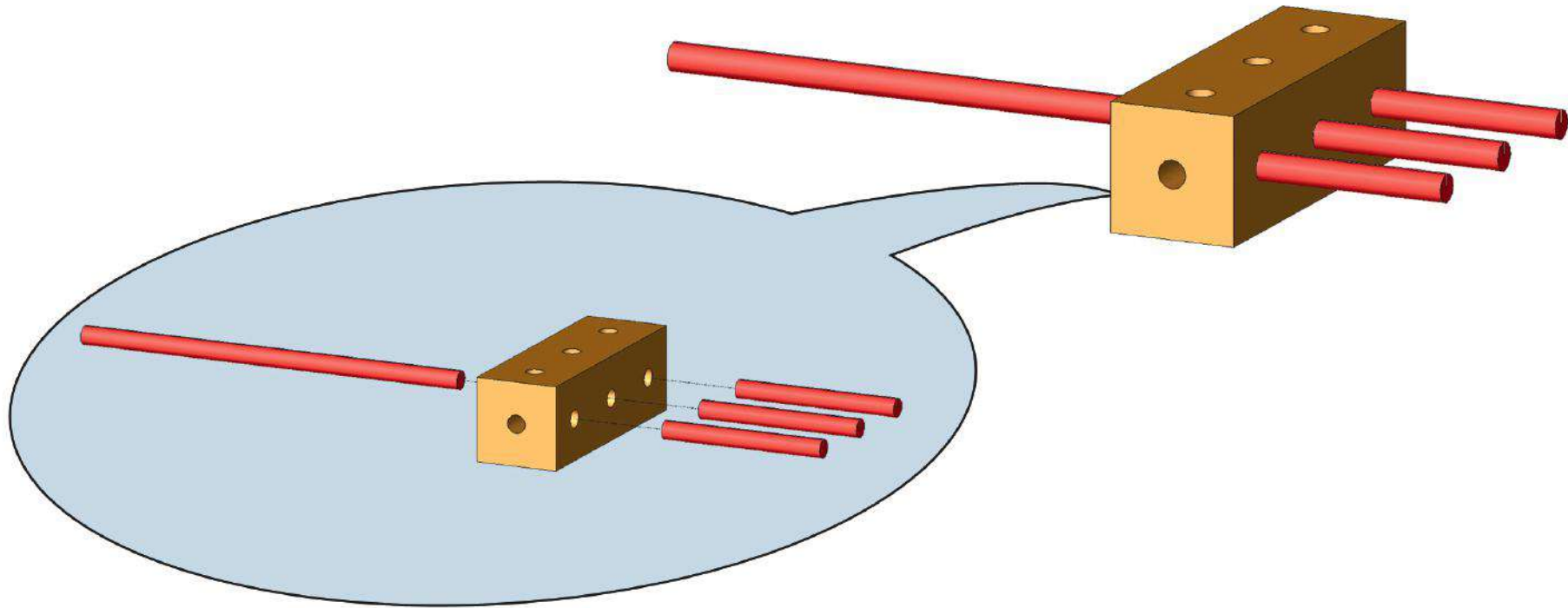

1x 

3x 

1x 

101

LEVEL

5+

x 18

10 min

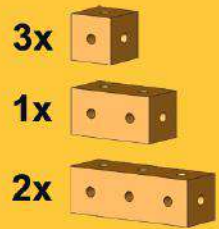
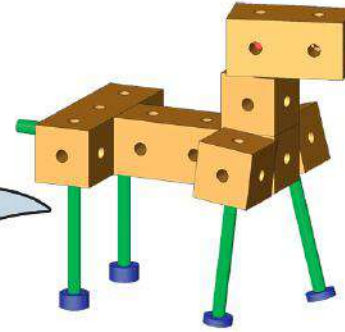
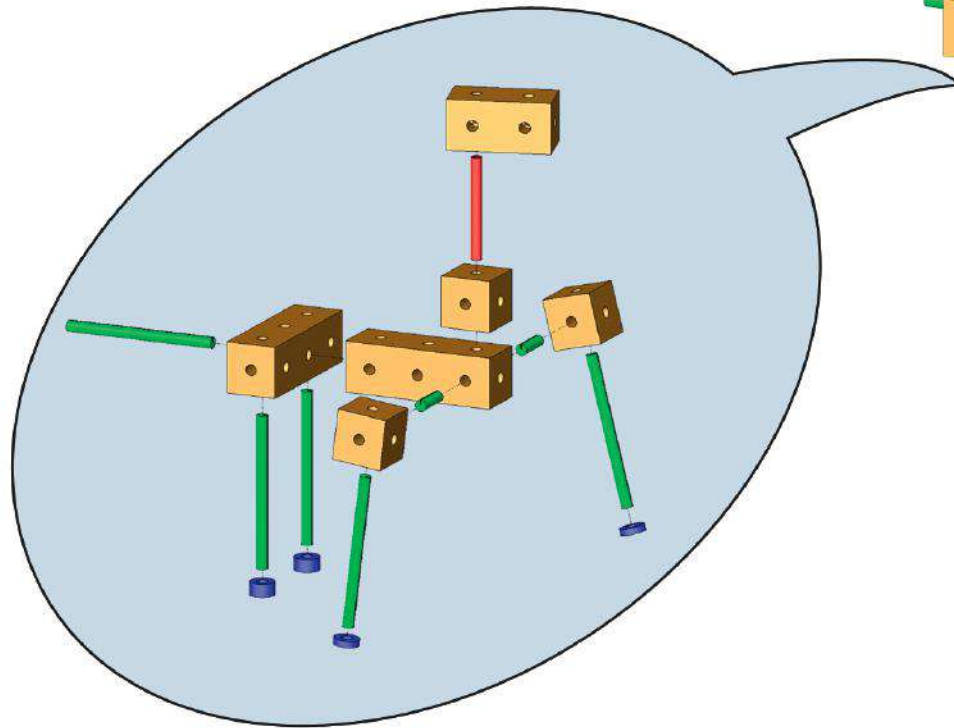

102

LEVEL

5+

x 38

20 min

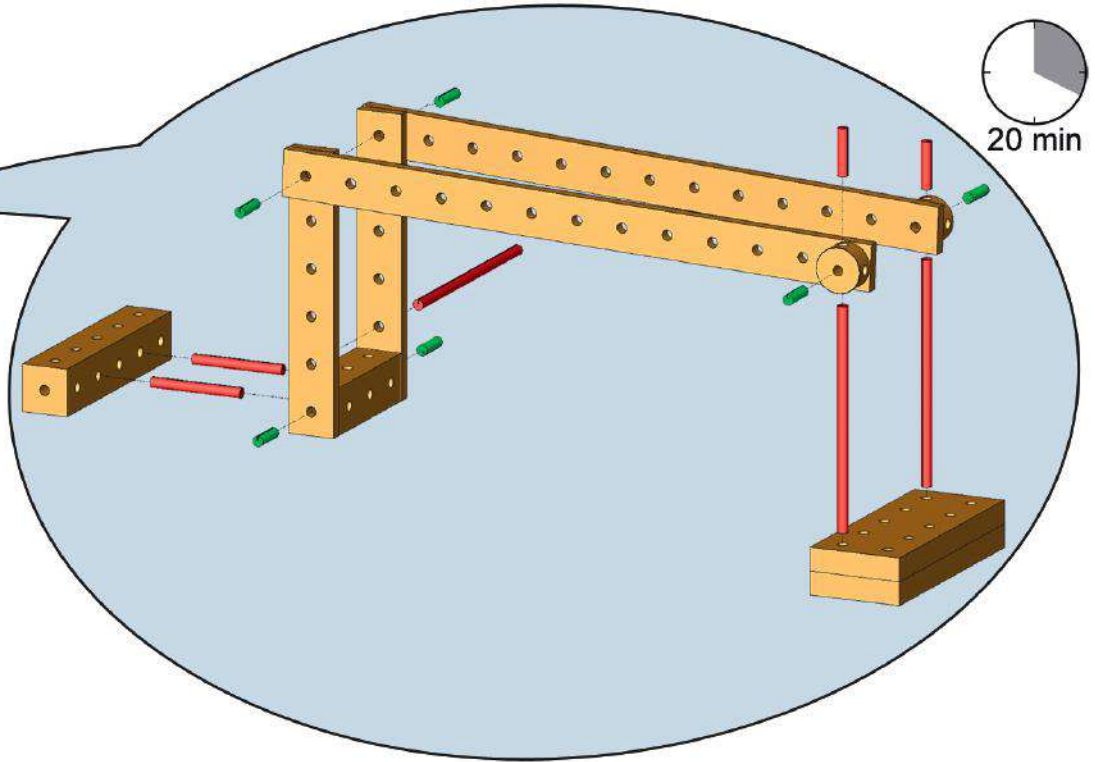
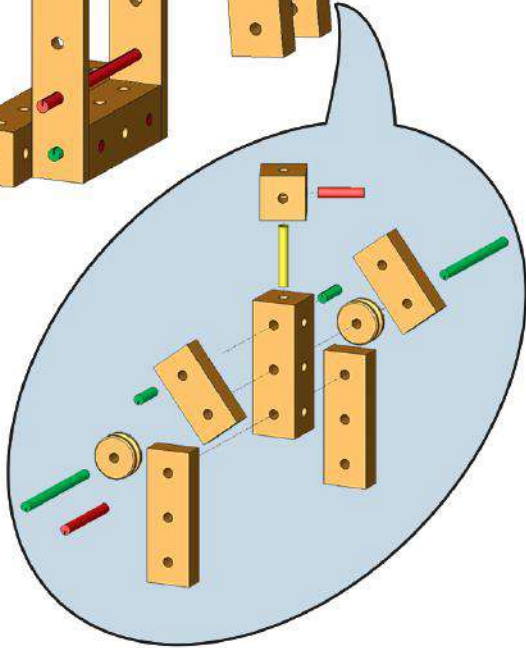
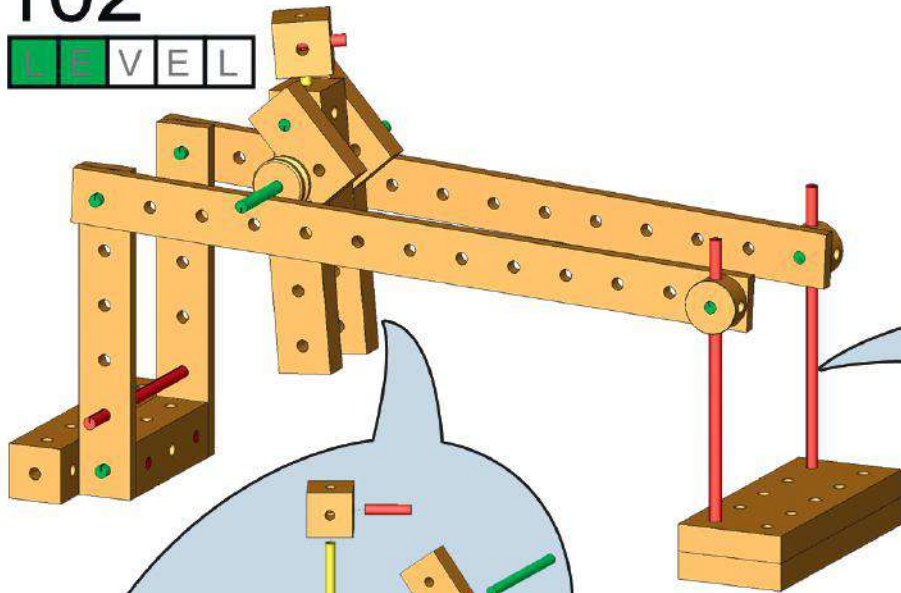

1x



2x



1x



2x



2x



2x



2x



2x



2x



2x



8x



3x



1x



3x



2x



3x



103

LEVEL

5+

x 39

20 min

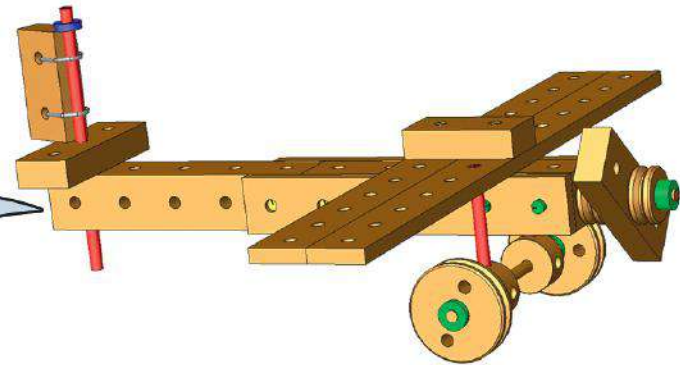
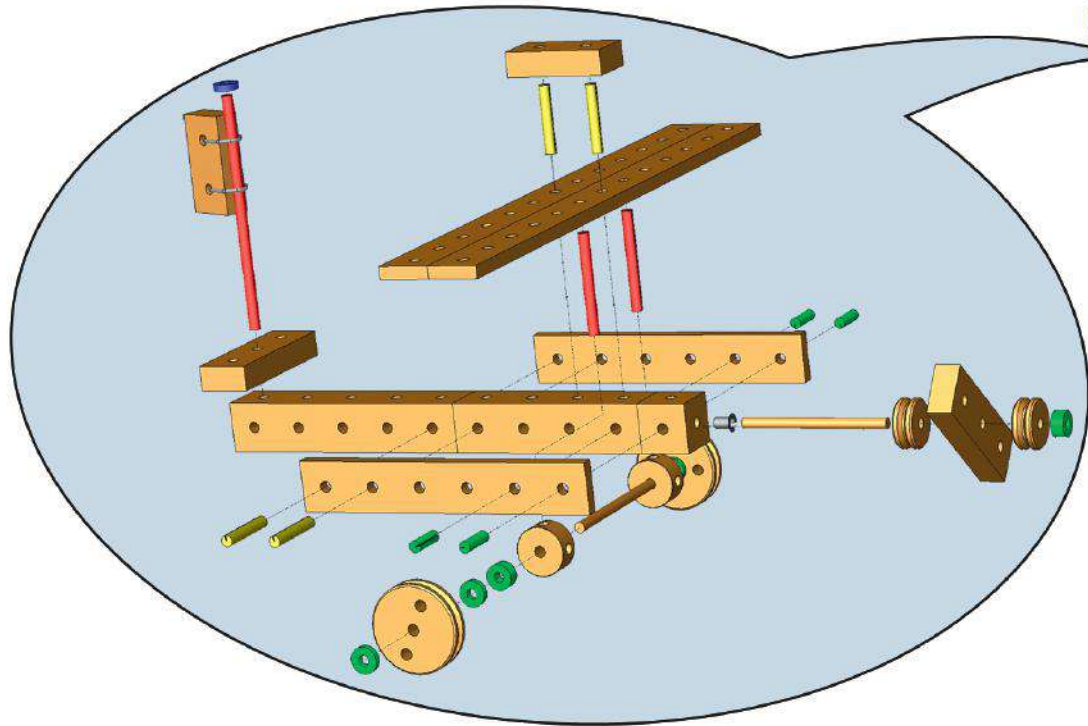

- 1x
- 1x
- 1x

- 2x
- 2x

- 1x
- 2x
- 2x
- 2x
- 2x
- 2x

- 4x
- 4x
- 2x
- 1x

- 1x
- 1x
- 1x
- 4x
- 3x
- 1x

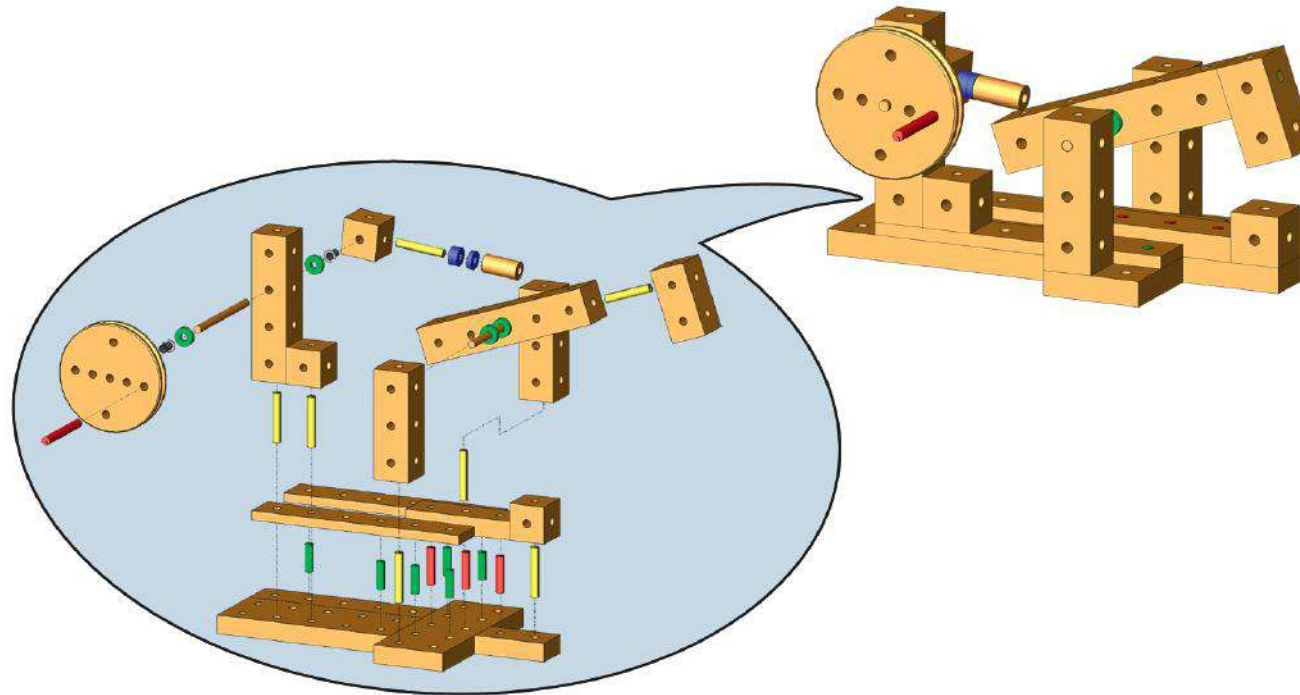

- 3x
- 1x
- 2x
- 1x
- 1x

- 1x
- 1x
- 1x
- 2x
- 1x

- 1x
- 2x
- 1x
- 1x
- 6x
- 2x

- 6x
- 3x
- 7x
- 1x

- 2x

105

LEVEL

5+

x 55

30 min

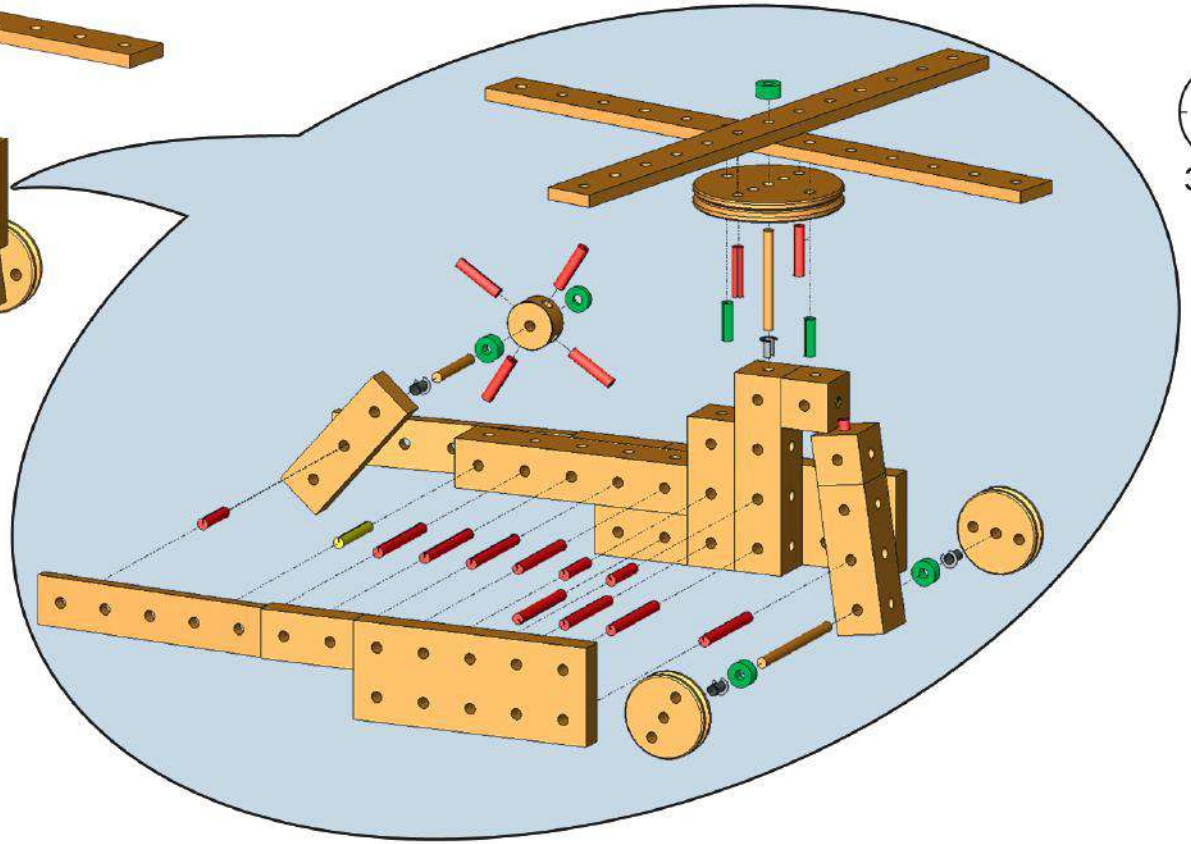
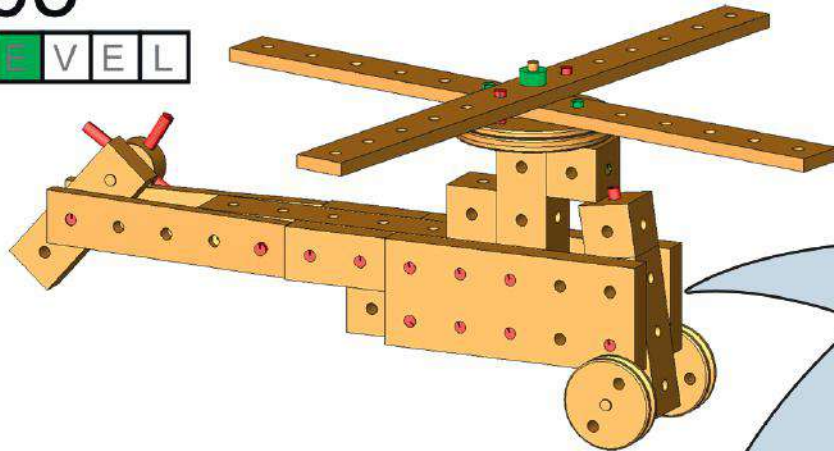

- 2x
- 1x
- 2x
- 1x
- 1x

- 2x
- 1x
- 2x
- 2x
- 2x

- 1x
- 2x
- 1x

- 2x
- 11x
- 1x
- 9x

- 1x
- 2x
- 1x
- 4x
- 4x

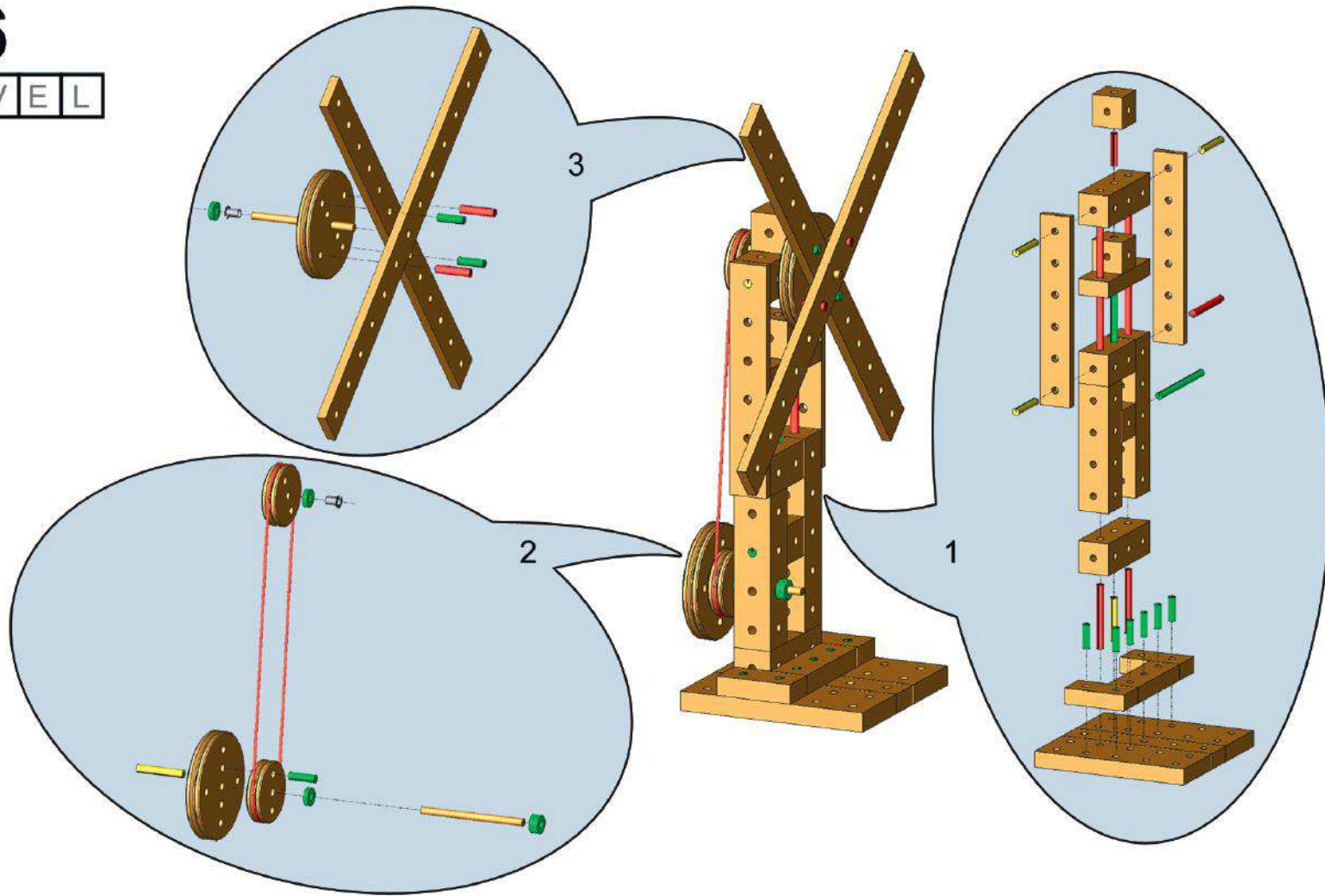

- 2x
- 1x
- 2x
- 1x
- 1x

- 2x
- 2x
- 1x
- 1x
- 2x

- 1x
- 2x
- 2x
- 2x
- 2x

- 3x
- 1x
- 2x

- 9x
- 3x
- 6x
- 3x
- 1x
- 2x

- 2x

107

LEVEL

5+

x 61

30 min

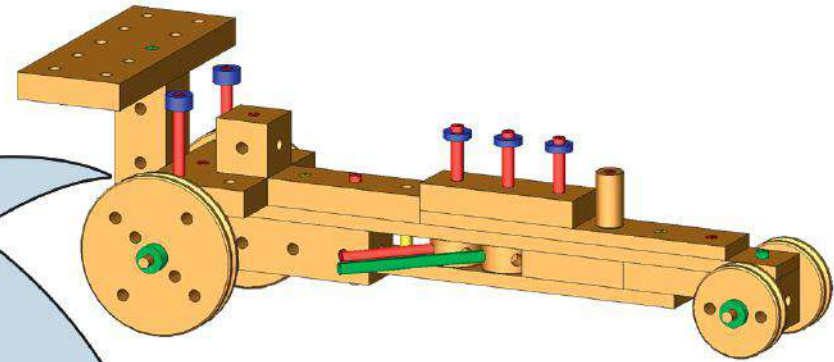
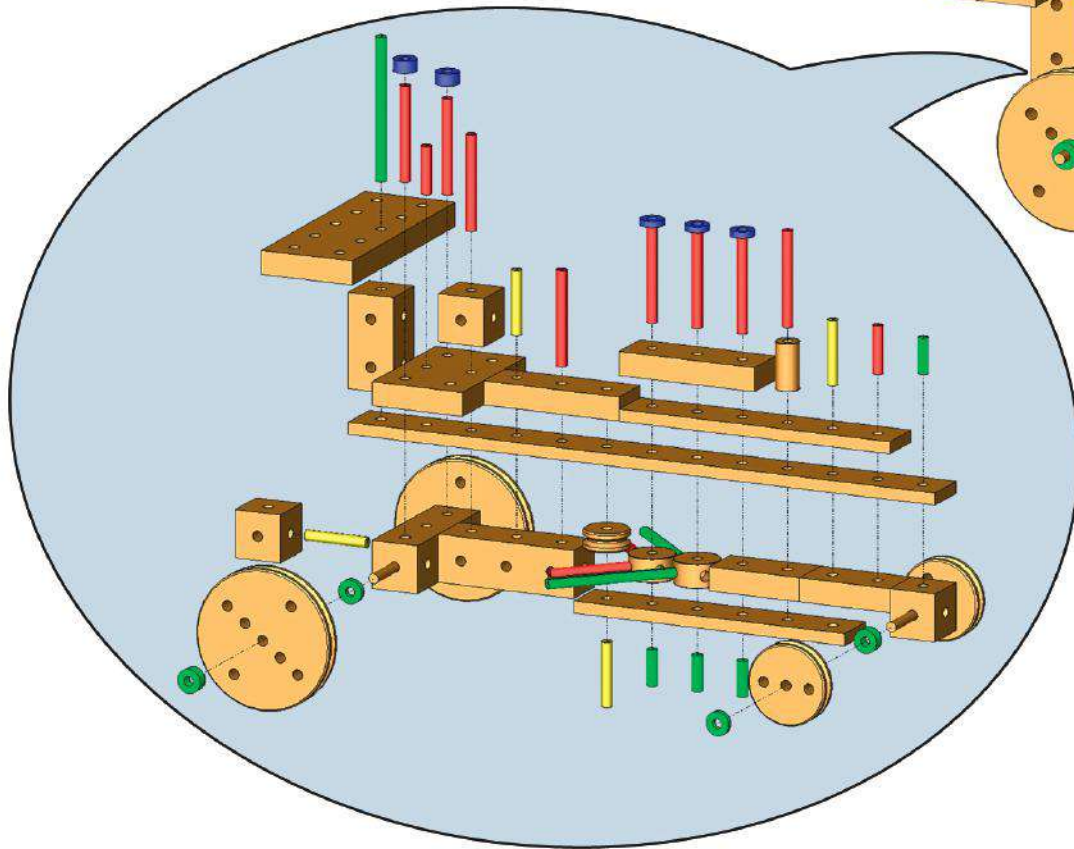

- 3x
- 1x
- 2x

- 2x
- 2x
- 1x
- 1x
- 2x
- 1x

- 2x
- 1x
- 2x
- 2x
- 1x

- 4x
- 2x
- 4x
- 10x
- 3x

- 1x
- 1x
- 3x
- 2x
- 4x
- 4x

108

LEVEL

5+

x 71

40 min

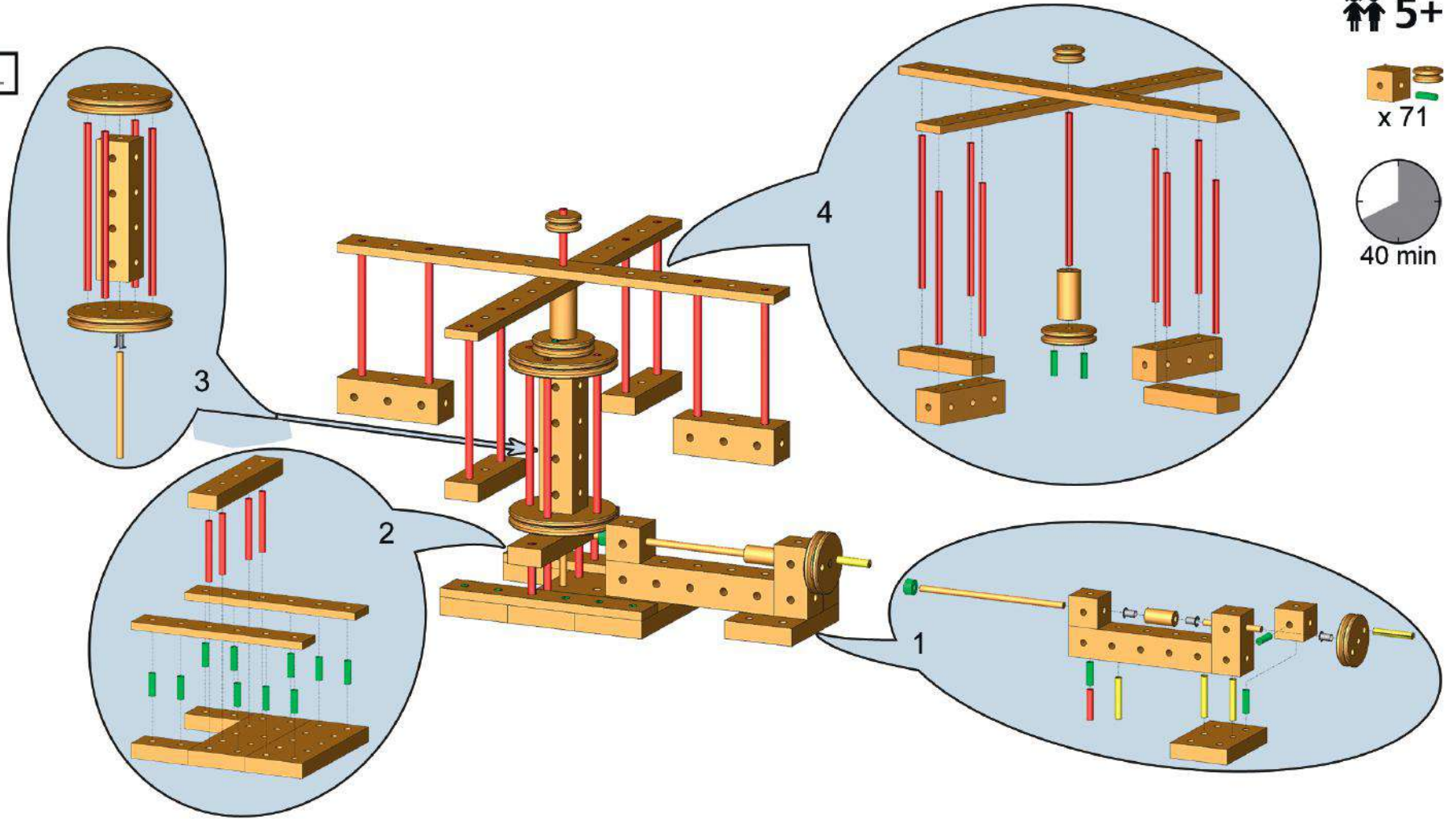

- 2x
- 1x
- 2x
- 1x
- 1x

- 1x
- 1x
- 2x
- 2x
- 1x
- 2x

- 1x
- 1x
- 2x
- 2x
- 2x
- 2x

1x

4x

- 15x
- 1x
- 4x
- 4x
- 13x

- 1x
- 1x
- 1x
- 1x

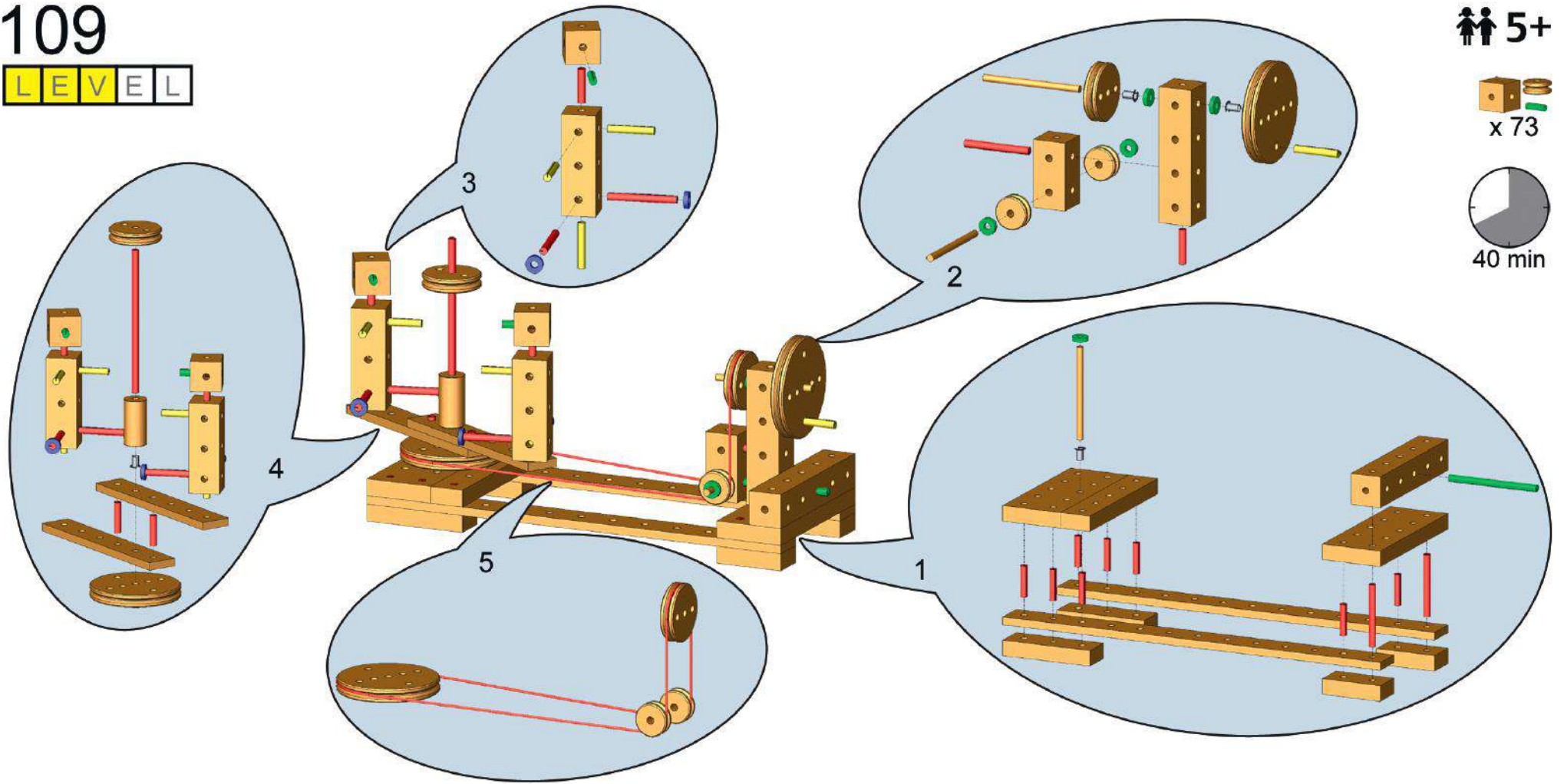

- 2x
- 1x
- 2x
- 1x
- 1x

- 1x
- 1x
- 2x
- 2x
- 1x
- 2x

- 3x
- 2x
- 2x
- 2x
- 2x
- 2x

- 4x
- 5x
- 4x

- 2x
- 13x
- 7x
- 7x
- 1x
- 1x

5+

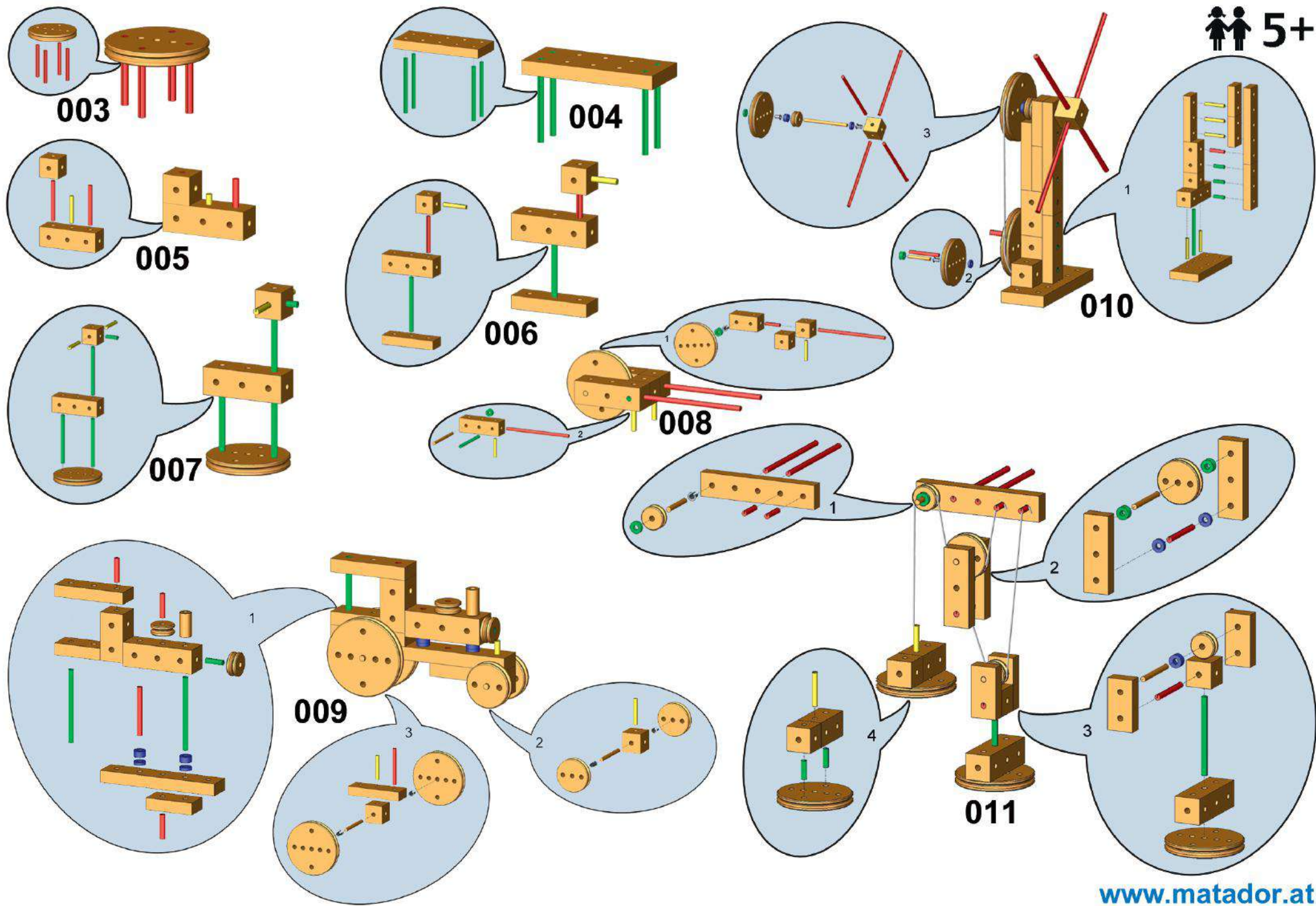

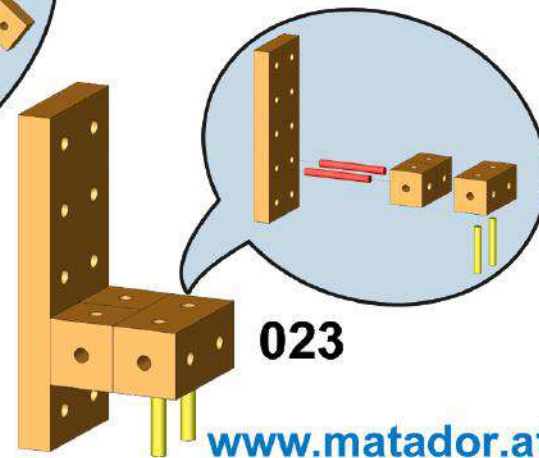
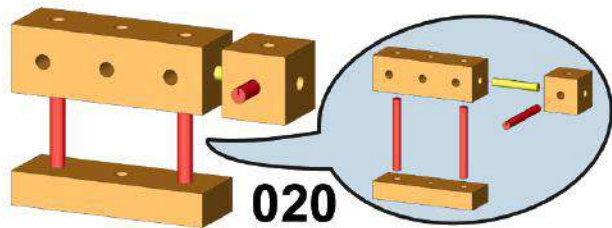
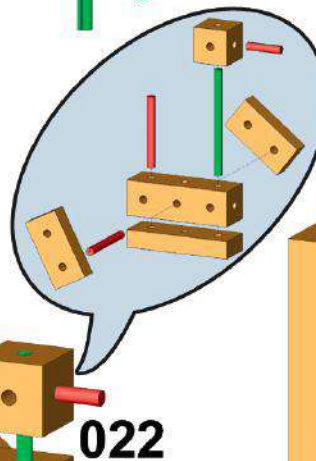
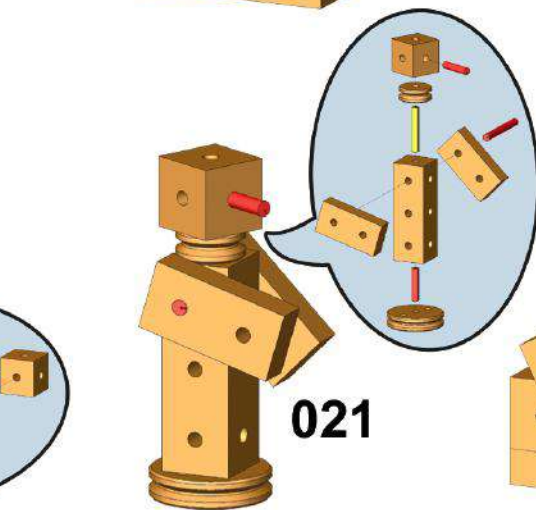
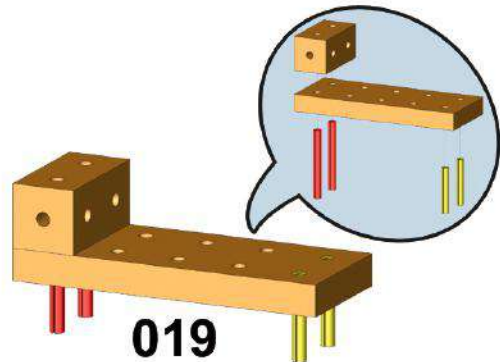
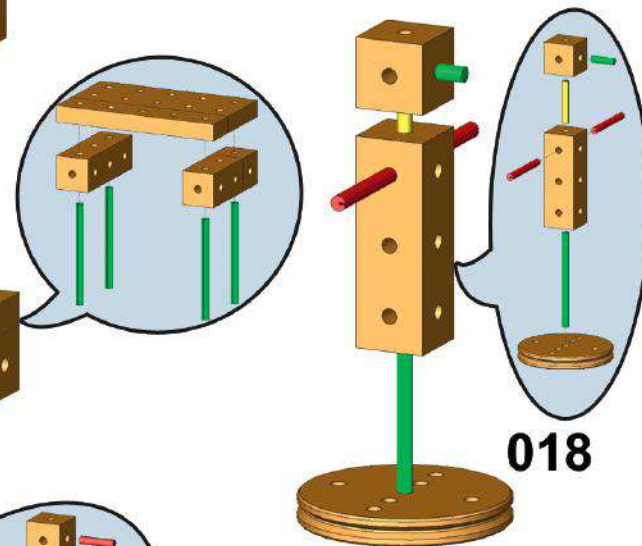
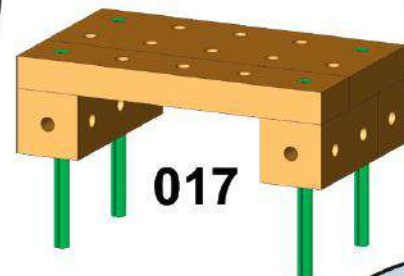
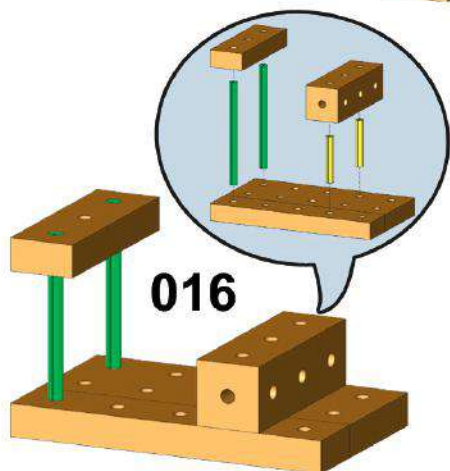
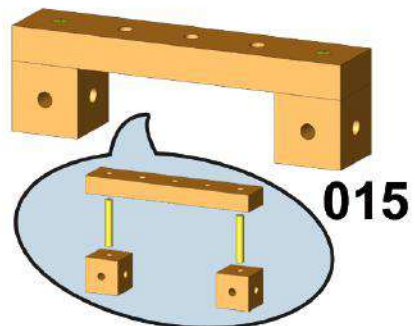
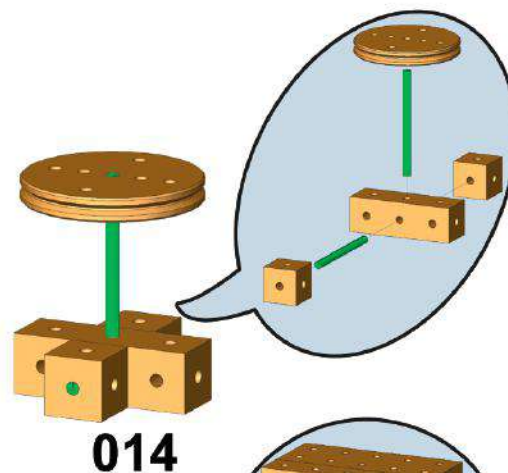
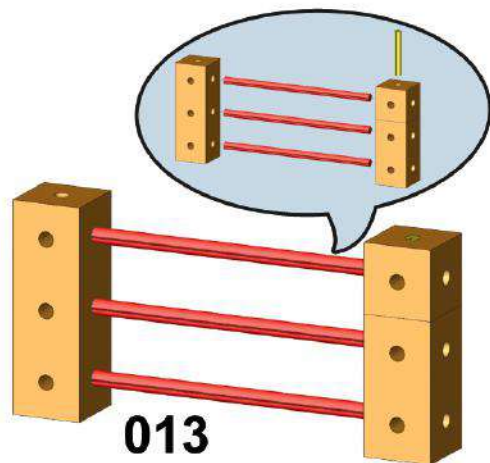
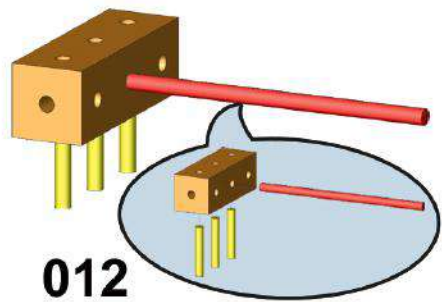

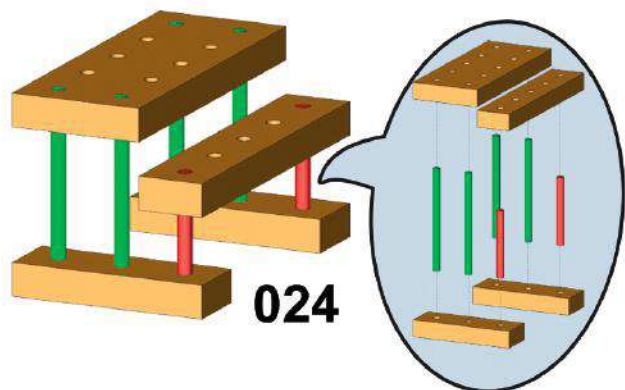

024

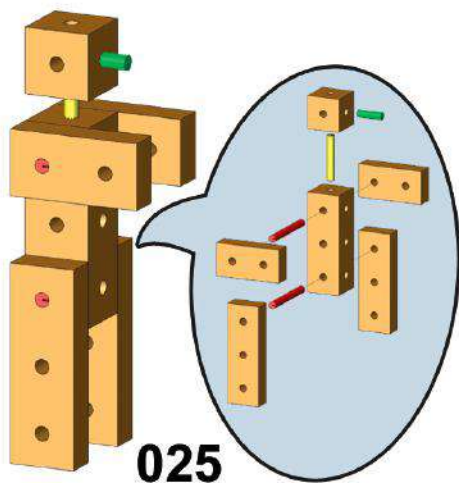

025

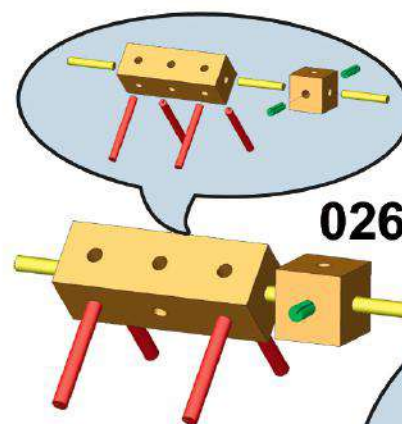

026

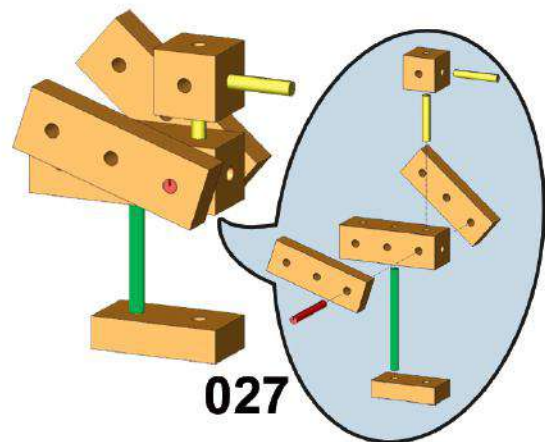

027

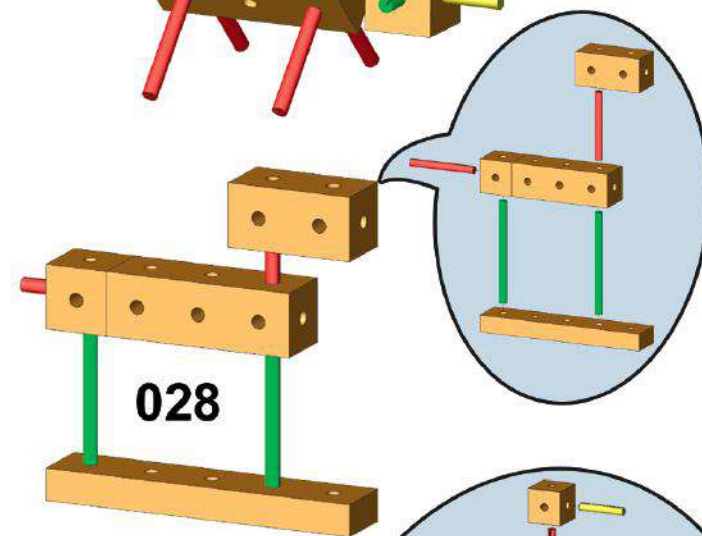

028

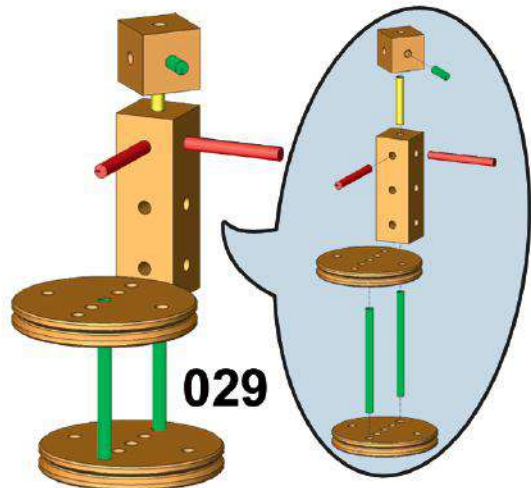

029

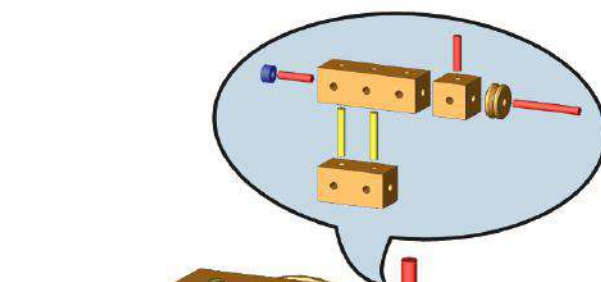

030

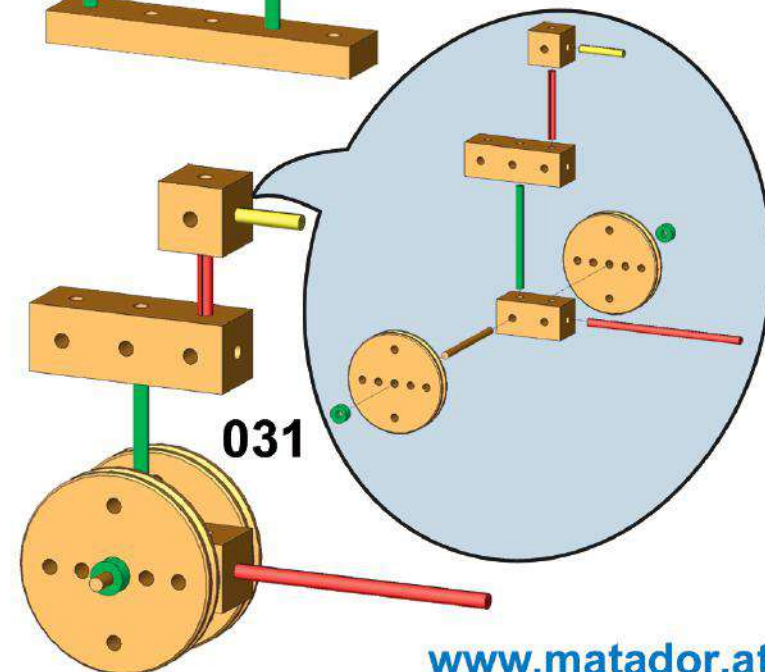

031

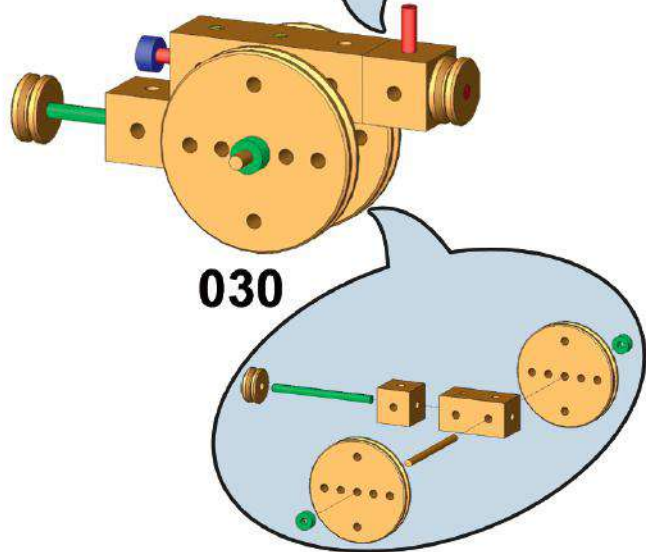

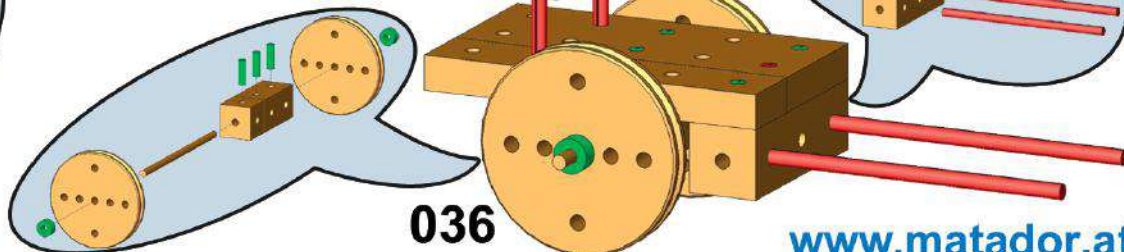
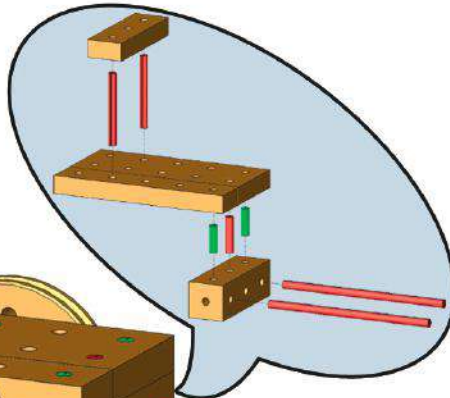
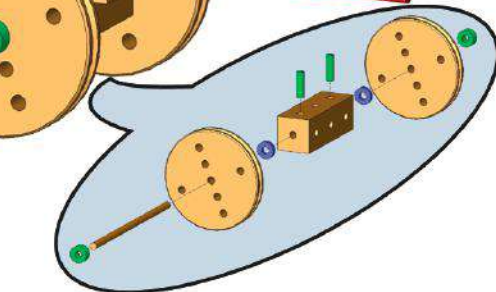
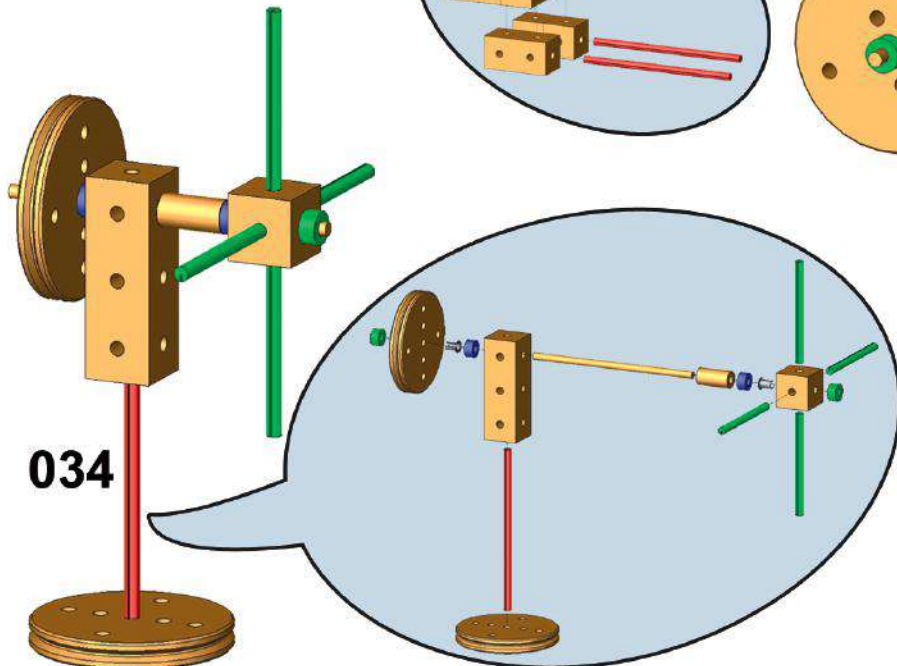
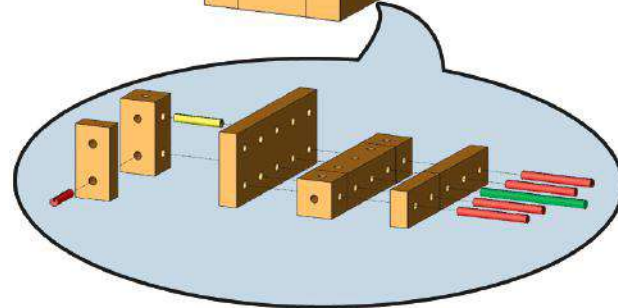
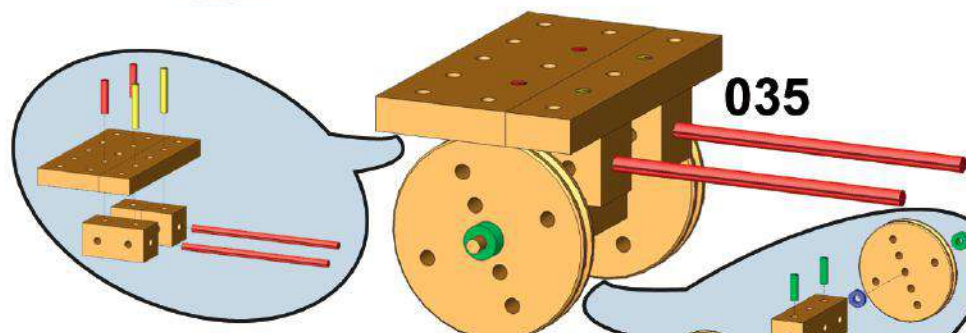
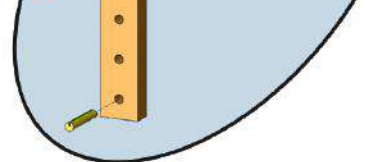
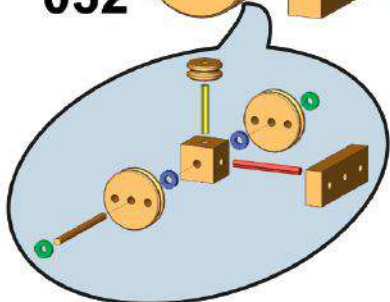
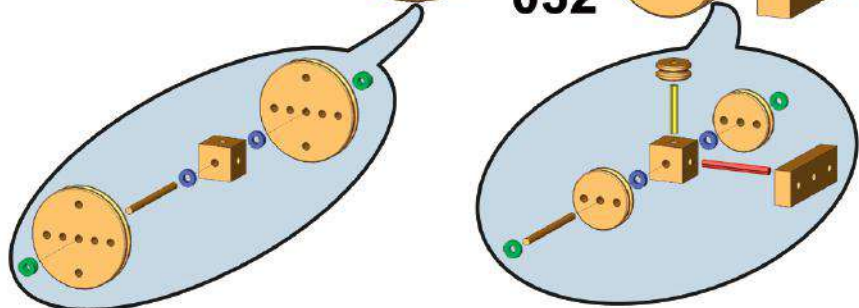
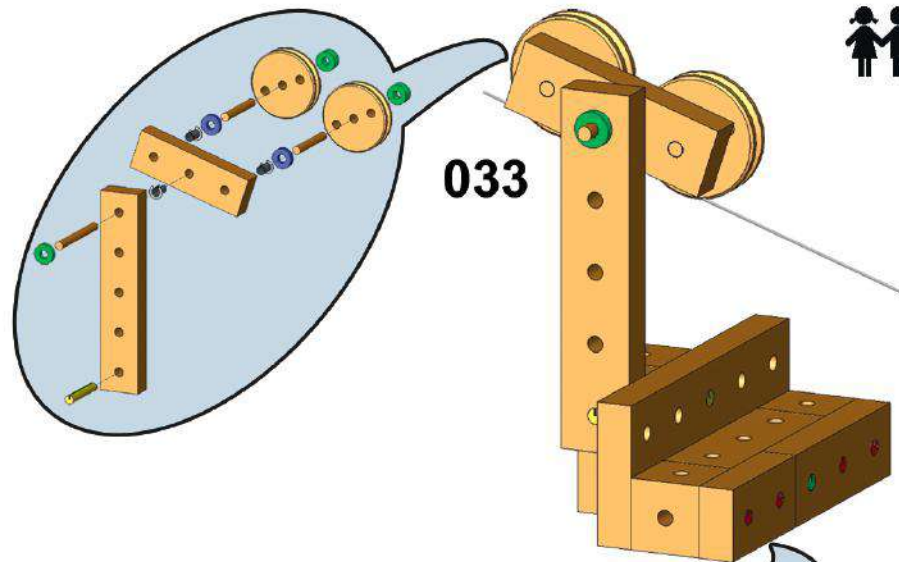
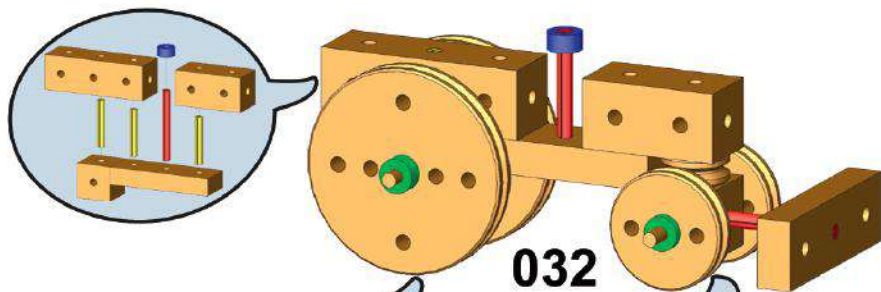

5+

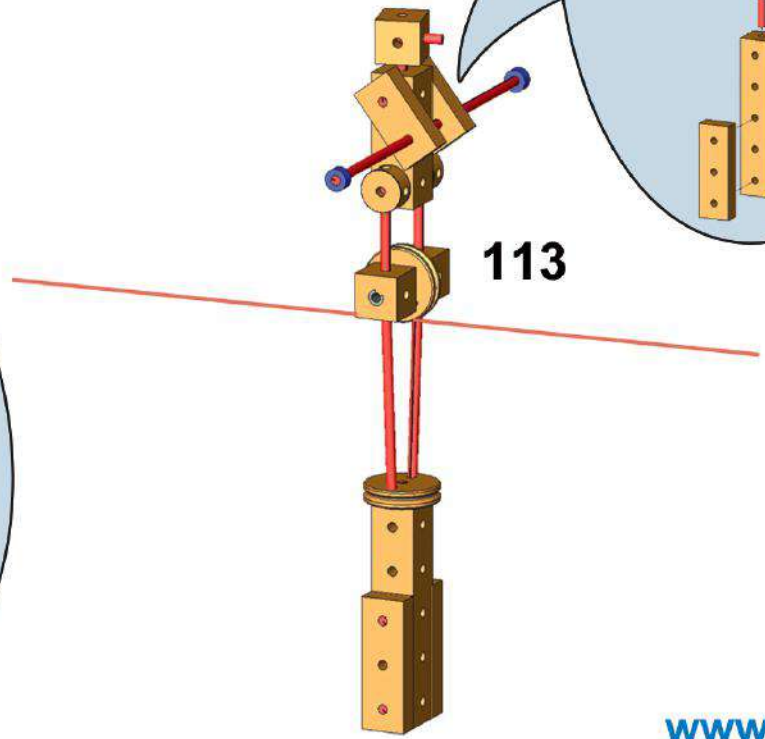
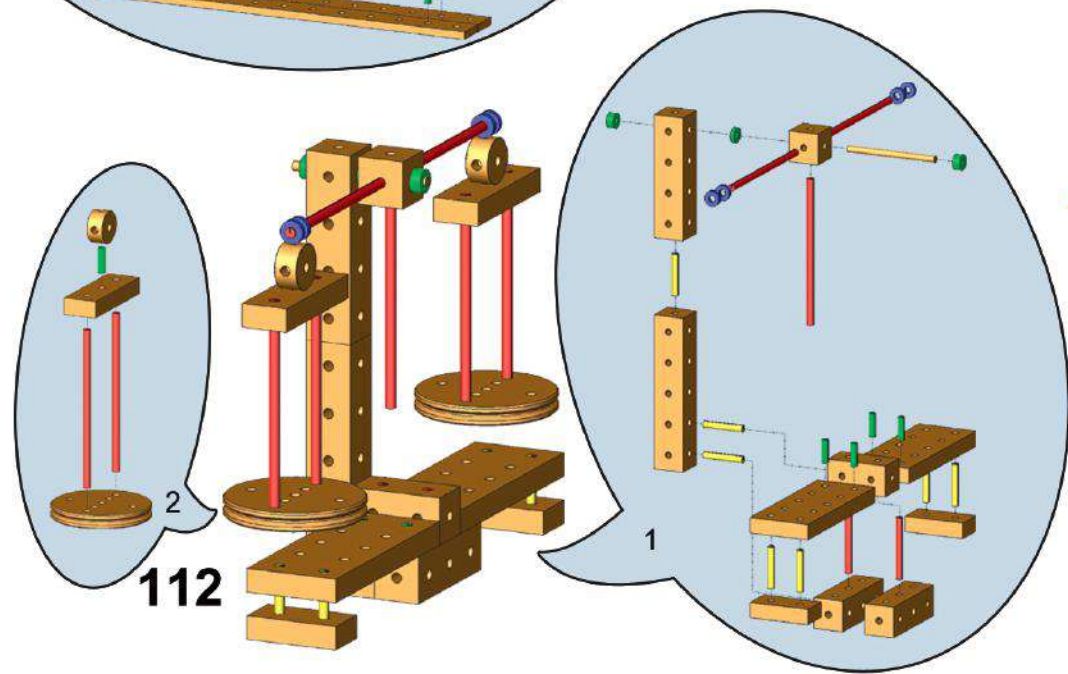
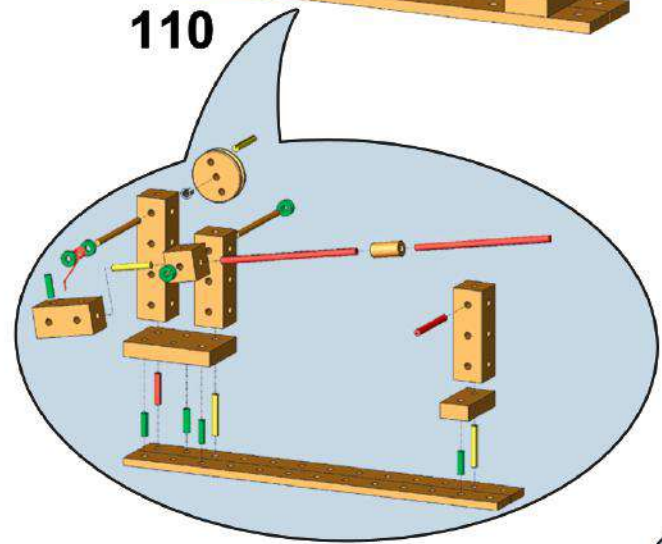
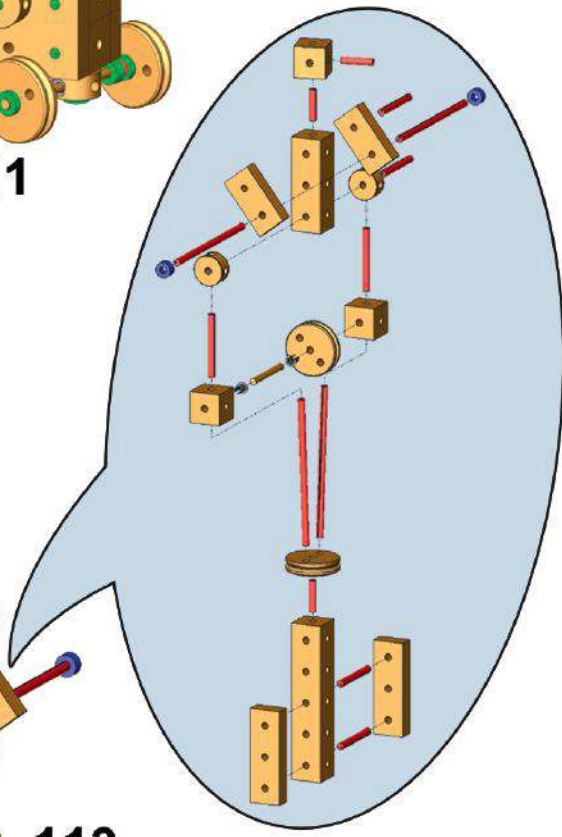
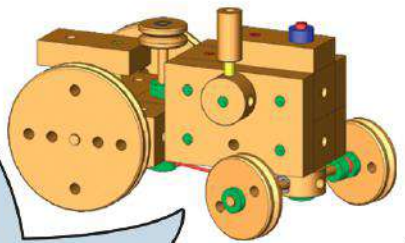
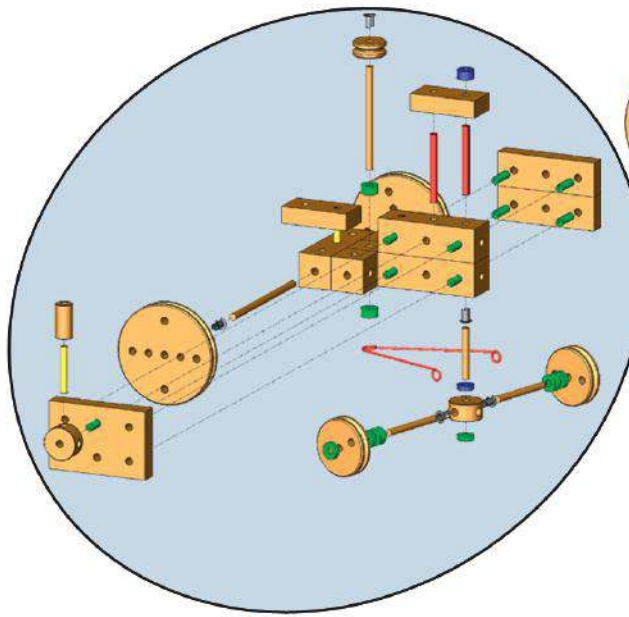
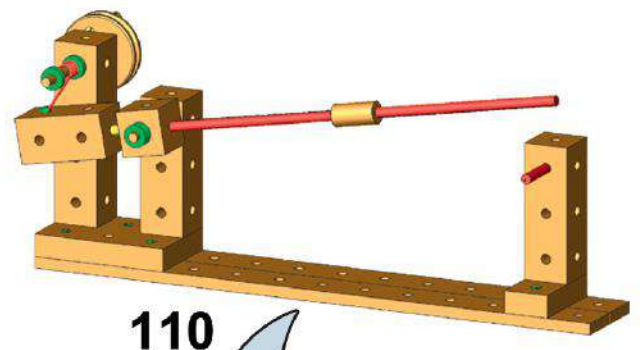

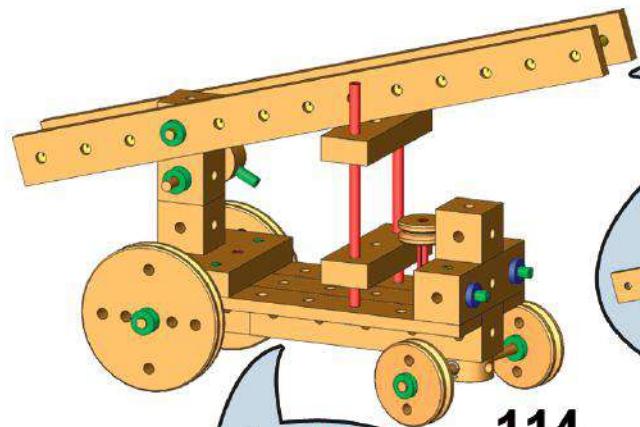

114

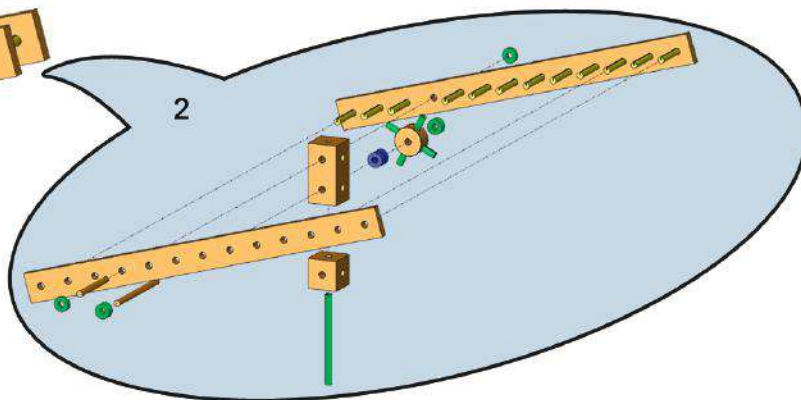
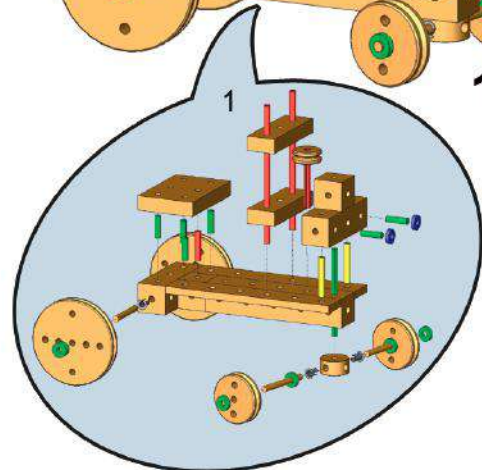

2

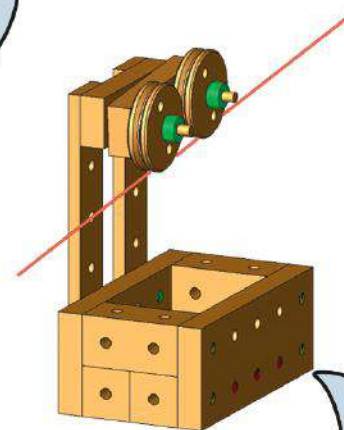

117

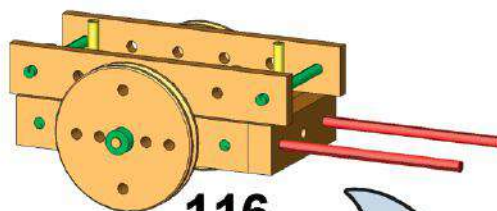
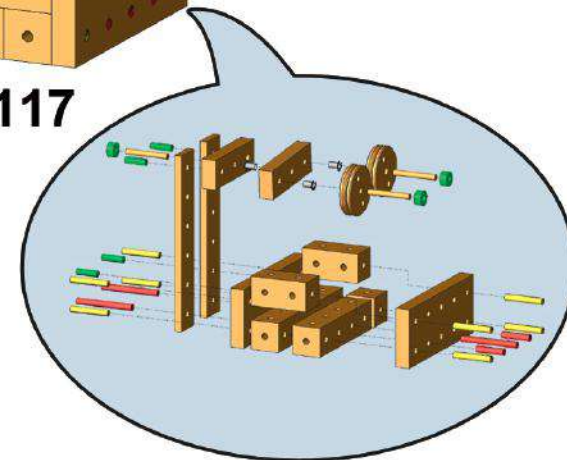

116

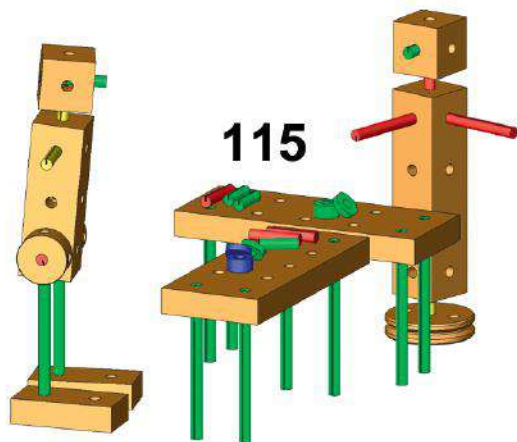
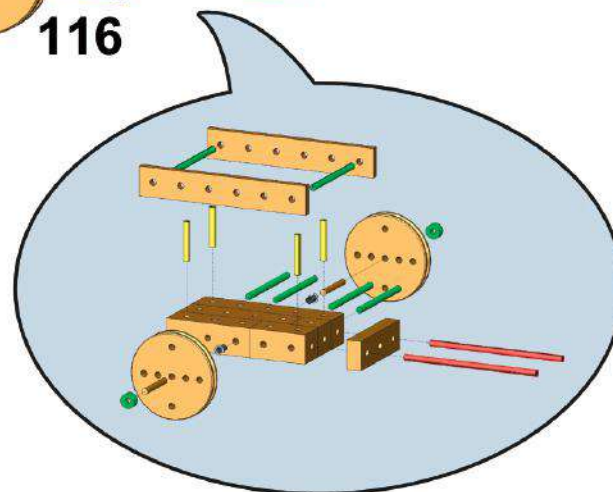

115

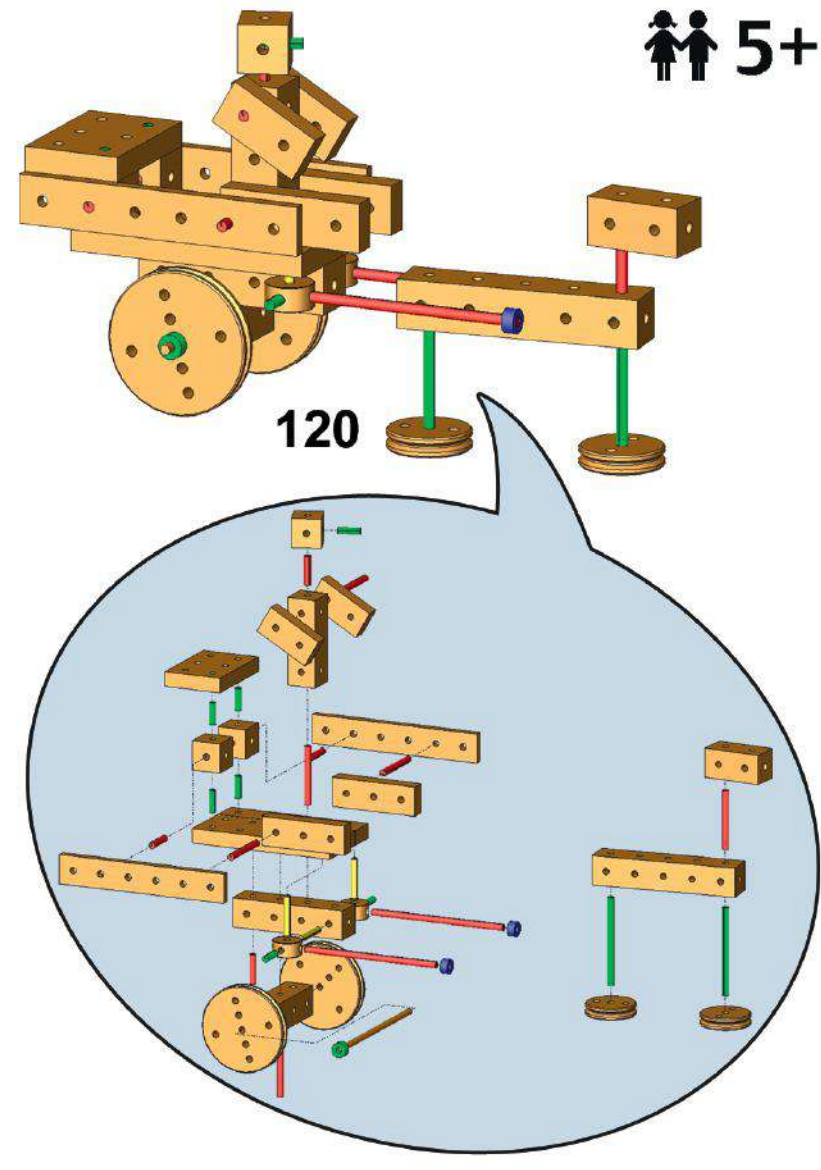
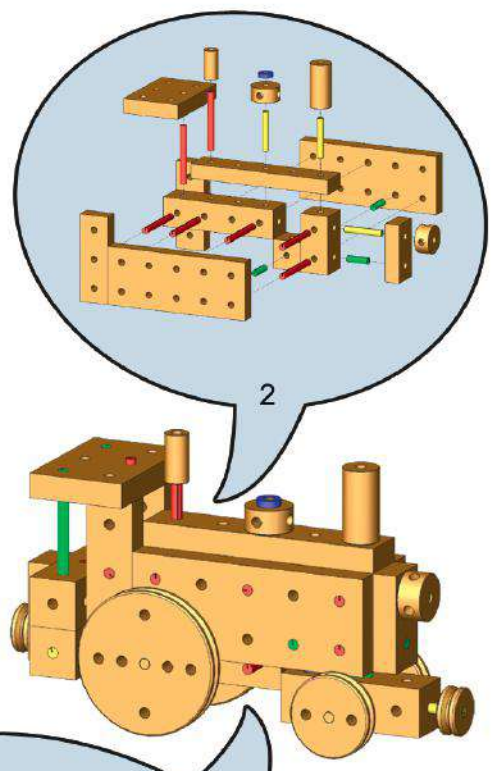
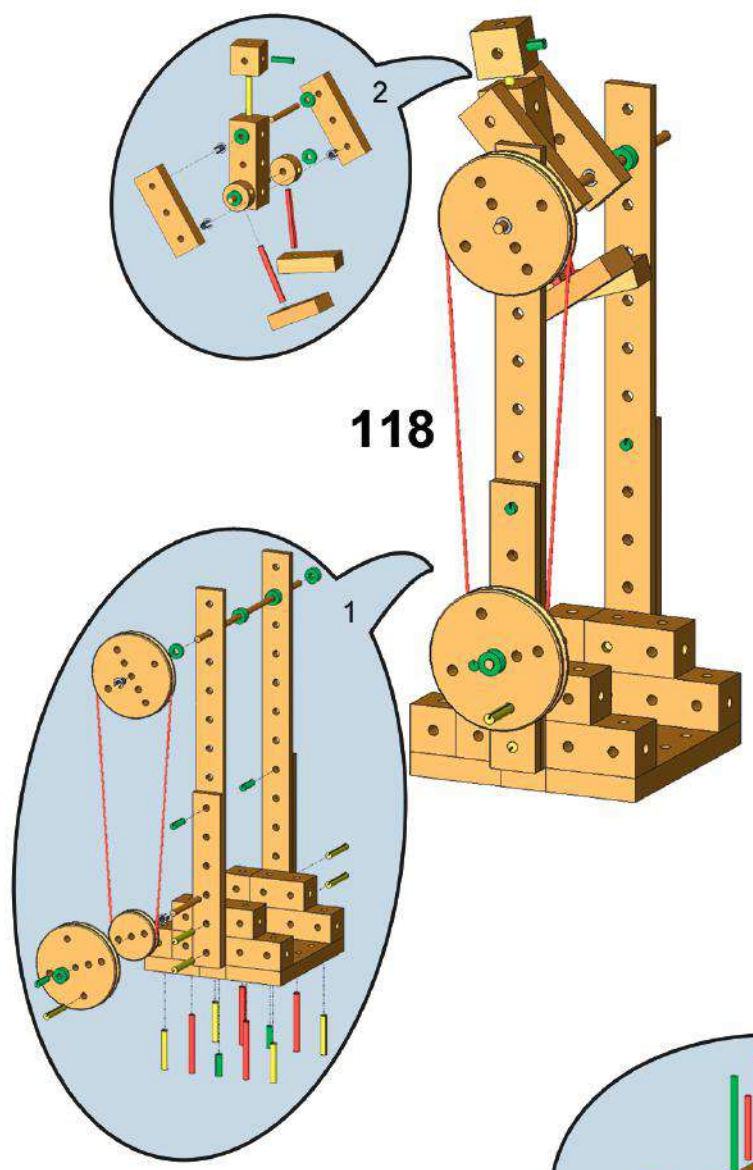

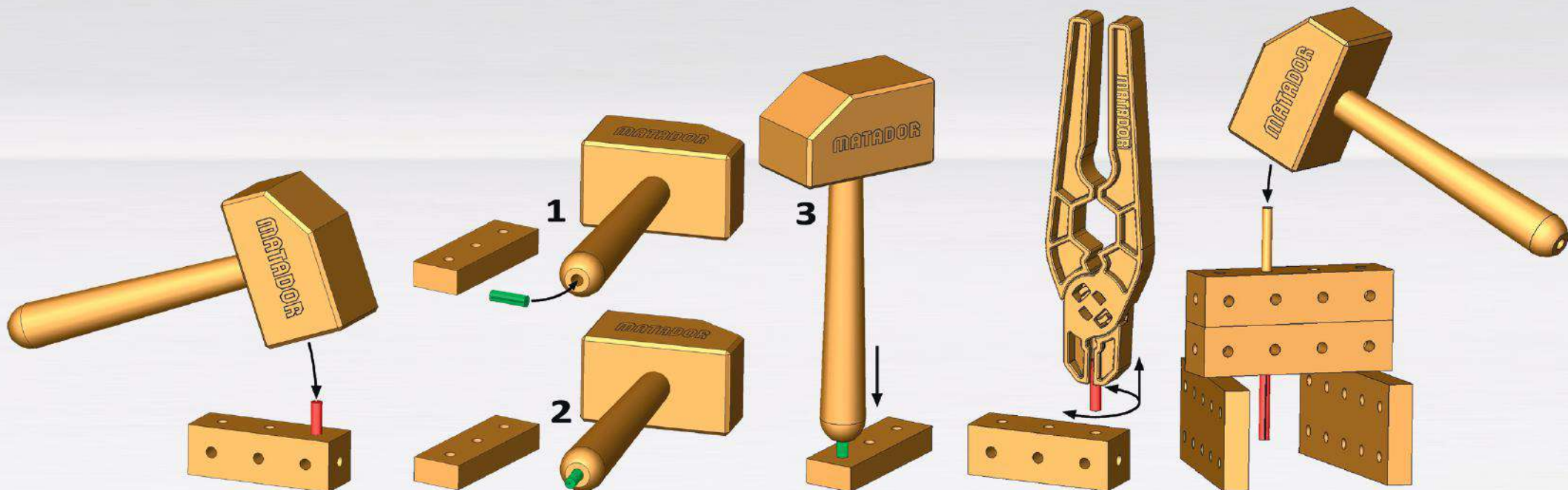

D: ACHTUNG! Nicht für Kinder unter 3 Jahren geeignet: verschluckbare Kleinteile – Erstickungsgefahr // Die Klemmhülsen weisen zweckbedingt scharfe Grate auf, was bei falscher Handhabung zu kleinen Schnittverletzungen führen kann. Daher müssen Kinder vor Verwendung des Spielzeuges auf diese Gefahr hingewiesen werden.

GB: ATTENTION! Not suitable for children under 36 months due to small pieces which may present a choking hazard - danger of suffocation // The clamping sleeves exhibit functionally sharp burrs, which can lead during wrong handling to small cuts. Therefore must be referred children before use of the toy to this danger.

F: ATTENTION! Ne convient pas aux enfants de moins de 36 mois - contient des petits éléments. - danger d'asphyxie // Les fixations, pour remplir leur fonction, présentent des angles vifs; en cas de mauvaise utilisation, elles peuvent générer des coupures bénignes. Attirez donc l'attention des enfants sur ce danger avant utilisation.

I: ATTENZIONE! Non adatto a bambini di età inferiore a 3 anni - contiene parti piccole - pericolo di soffocamento. - il pericolo dell'asfissia // I serrafilo per via della loro funzione hanno i margini non arrotondati; un uso non attento potrebbe provocare piccoli tagli. Perciò avvertite i bambini di questo pericolo prima dell'utilizzo del gioco.

NL: WAARSCHUWING! Niet geschikt voor kinderen jonger dan 36 maanden - kleine onderdelen - verstikking // De klemhulzen hebben door het doel waarvoor ze bestemd zijn scherpe randen, hetgeen bij verkeerd gebruik kleine snijwonden tot gevolg kan hebben. Om deze reden dienen kinderen hierop attent te worden gemaakt voordat het speelgoed wordt benut.

E: ADVERTENCIA! No es conveniente para ni os menores de 36 meses - pequeñas piezas - asfixia // Las boquillas de sujeción de acuerdo a su finalidad presentan bordes afilados, lo que en caso de manejo inadecuado puede ocasionar pequeñas heridas incisivas. Antes de usar los juguetes advertir a los niños sobre este peligro.

SLO: POZORI! Ni primerno za otroke, mlajše od 3 let, saj vsebuje drobne delce, ki jih otrok lahko pogoltnje ali vdahne. // Vpenjalni tulci so funkcionalno ostri, ki lahko med napačnim ravnanjem vodijo do majhnih rezov. Zato je treba otroke pred uporabo igrarče napotiti na to nevarnost.

HU: FIGYELEM! Három évesnél fiatalabb gyermekek számára nem alkalmas. A lenyelhető apró alkatrészek miatt fulladásveszély áll fenn! // A szorító hüvelyek funkcionálisan éles sorjakat mutatnak, amelyek a helytelen kezelés során kisebb vágásokhoz vezethetnek. Ezért a játék használata előtt a gyermekeket erre a veszélyre kell irányítani.



MATADOR Ersatzteilservice

Bauteil verloren? -Kein Problem!

Der MATADOR - Kundenservice ist auch nach dem Kauf für Sie da! Bei der Entwicklung und Produktion unserer Produkte stehen bei uns die Qualität und die Kundenzufriedenheit an erster Stelle. Besuchen Sie auch unseren Online-Shop!

MATADOR spare parts service

Lost parts? -No problem!

The MATADOR customer service is also available after your purchase! In the development and production of our products, the quality and the customer-satisfaction are the most important things for us. Visit our Online Shop!



MATADOR[®]

EXPLORER
E318

5+



MADE IN AUSTRIA

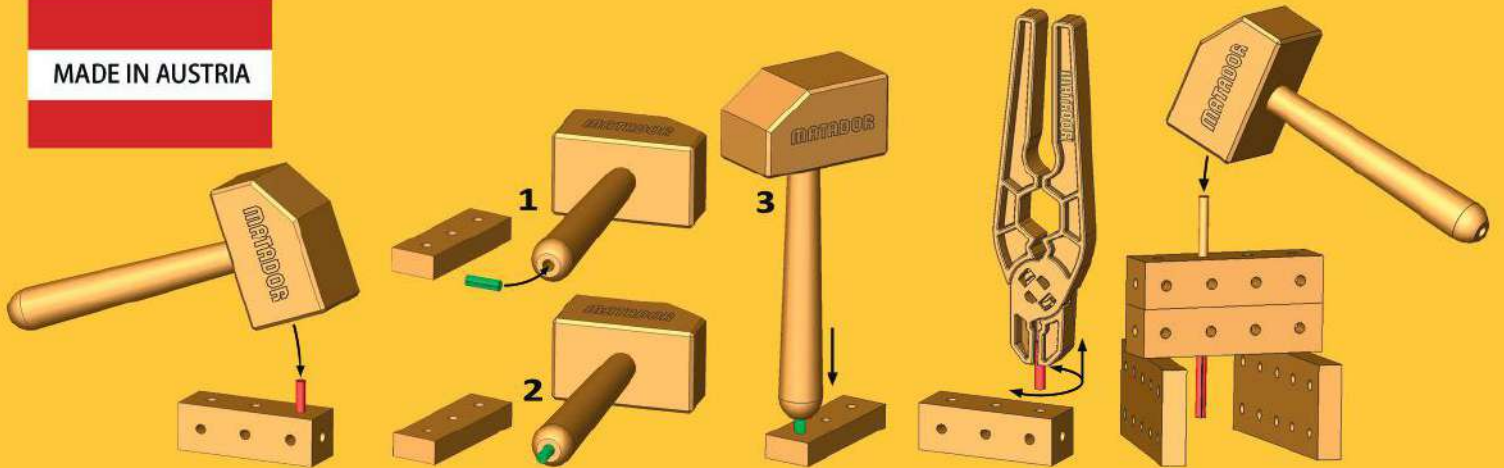

001

EVEL

5+

x 2

1 min

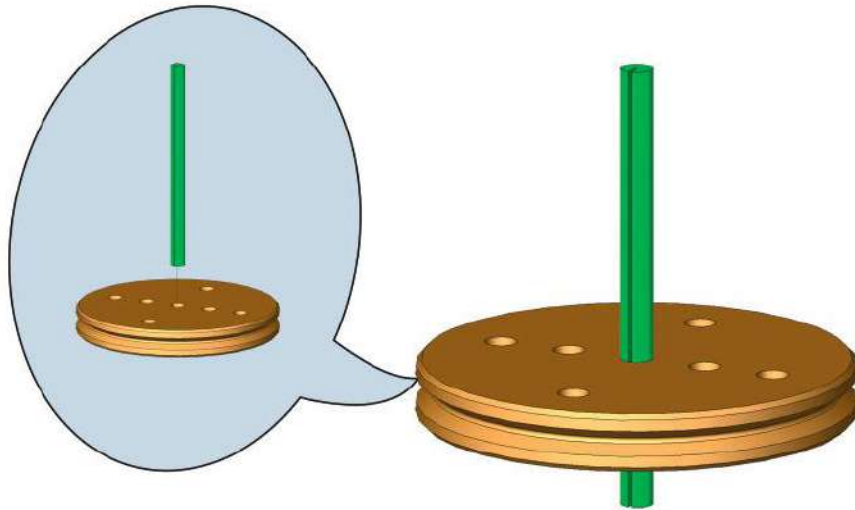

1x 

1x 

002

EVEL

5+

x 5

2 min

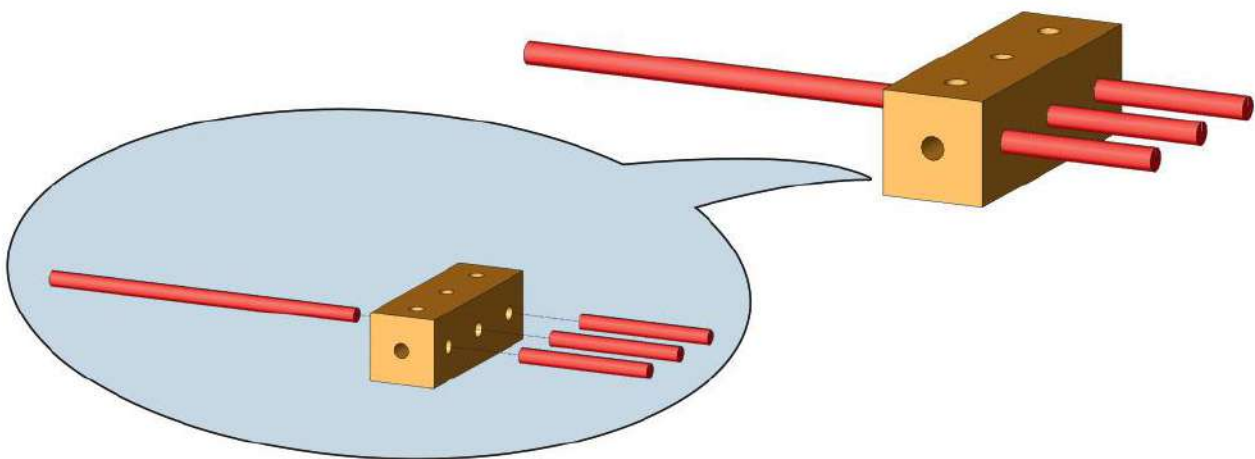

1x 

3x 

1x 

101

VEL

5+

x 18

10 min

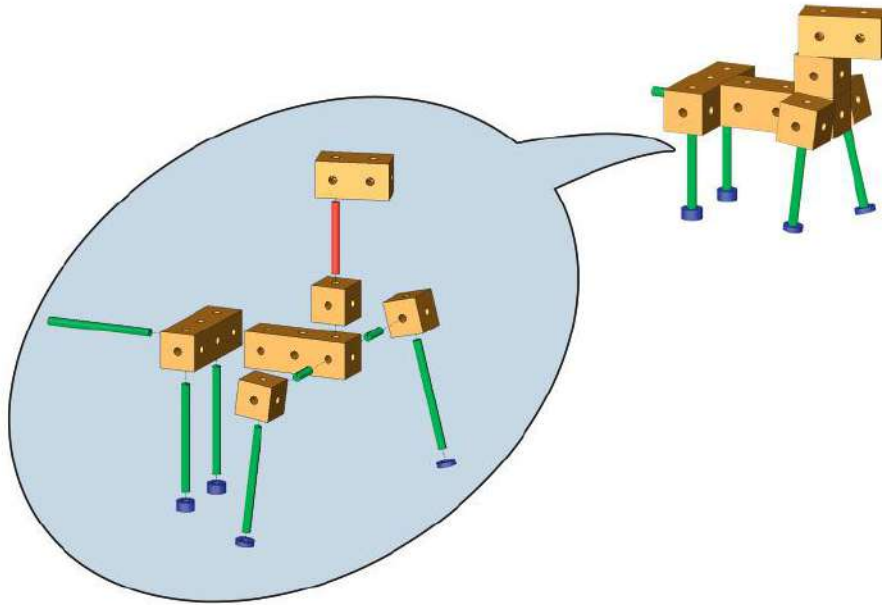

- 3x
- 1x
- 2x

- 2x
- 2x
- 1x
- 5x

105

VEL

5+

x 55

30 min

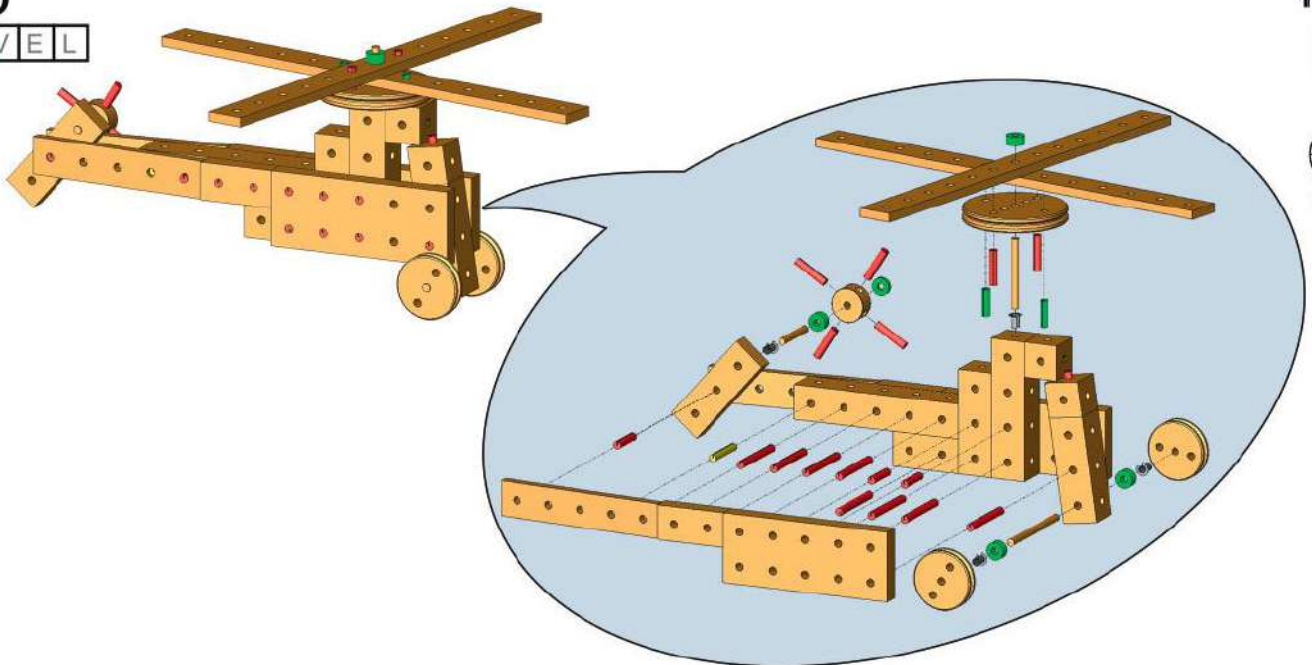

- 2x
- 1x
- 2x
- 1x
- 1x

- 2x
- 1x
- 2x
- 2x
- 2x

- 1x
- 2x
- 1x

- 2x
- 11x
- 1x
- 9x

- 1x
- 2x
- 1x
- 4x
- 4x

201

VEL

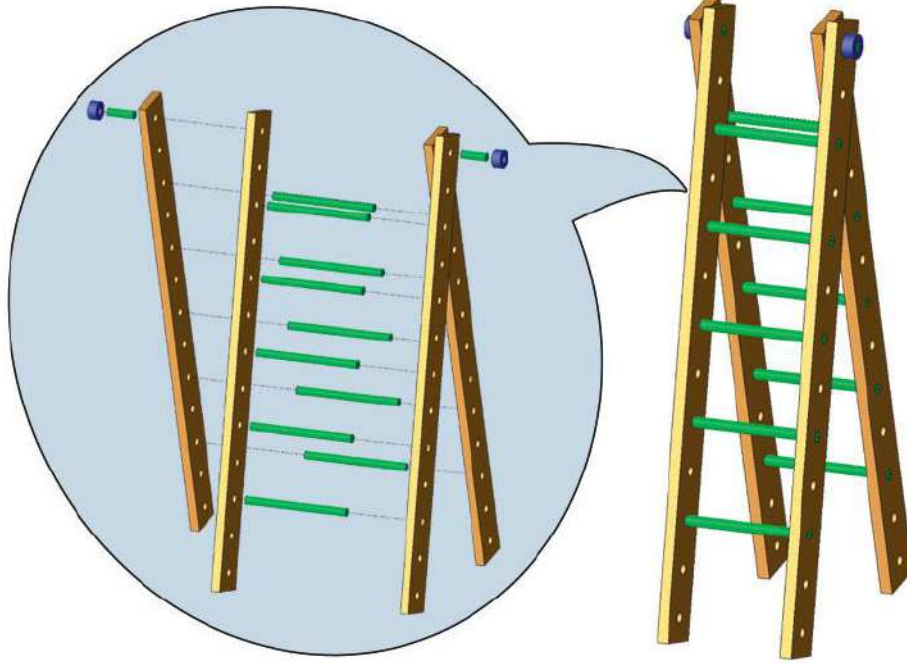

5+

x 16

10 min



202

VEL

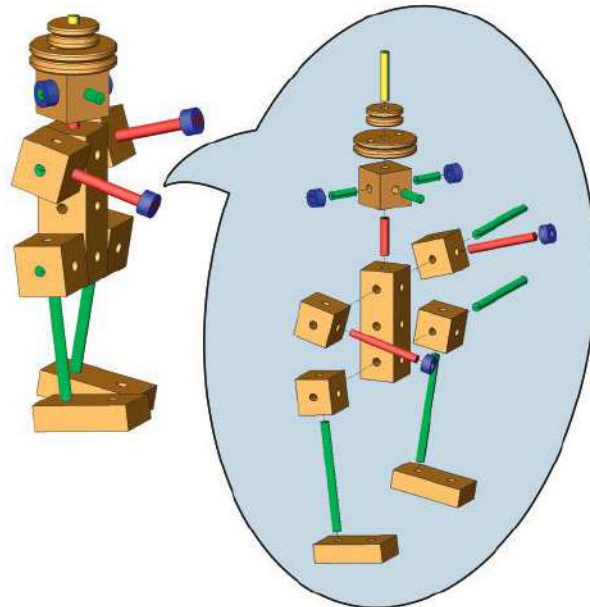

5+

x 25

15 min



203

VEL

5+

x 30

15 min

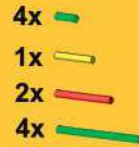
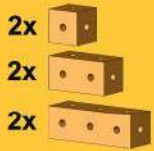
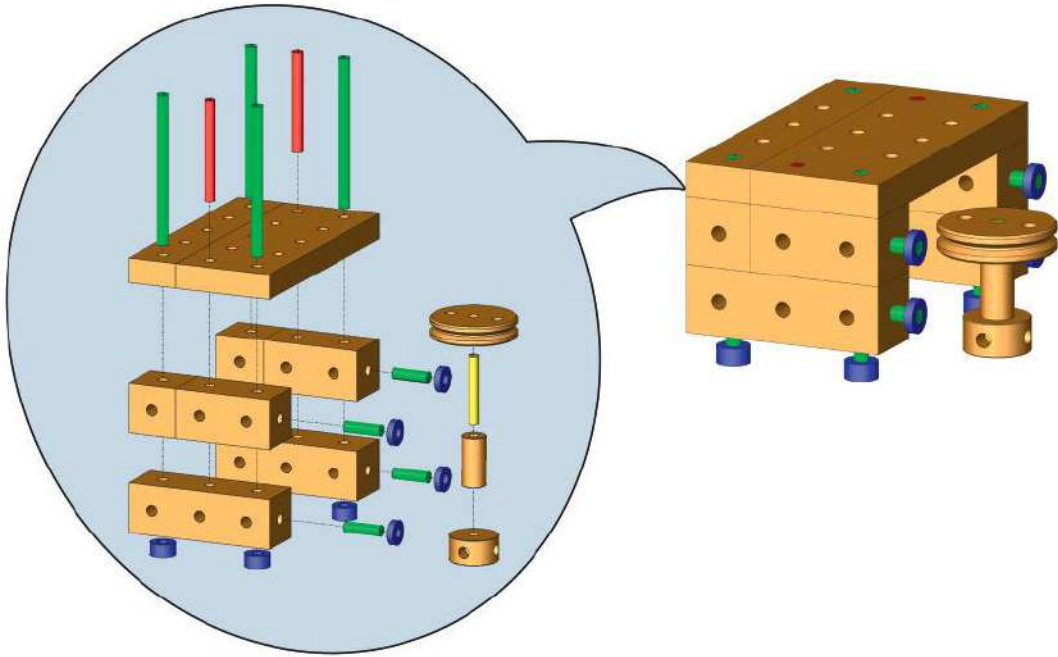

204

VEL

5+

x 48

30 min

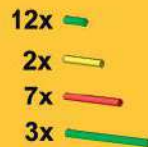
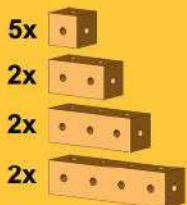
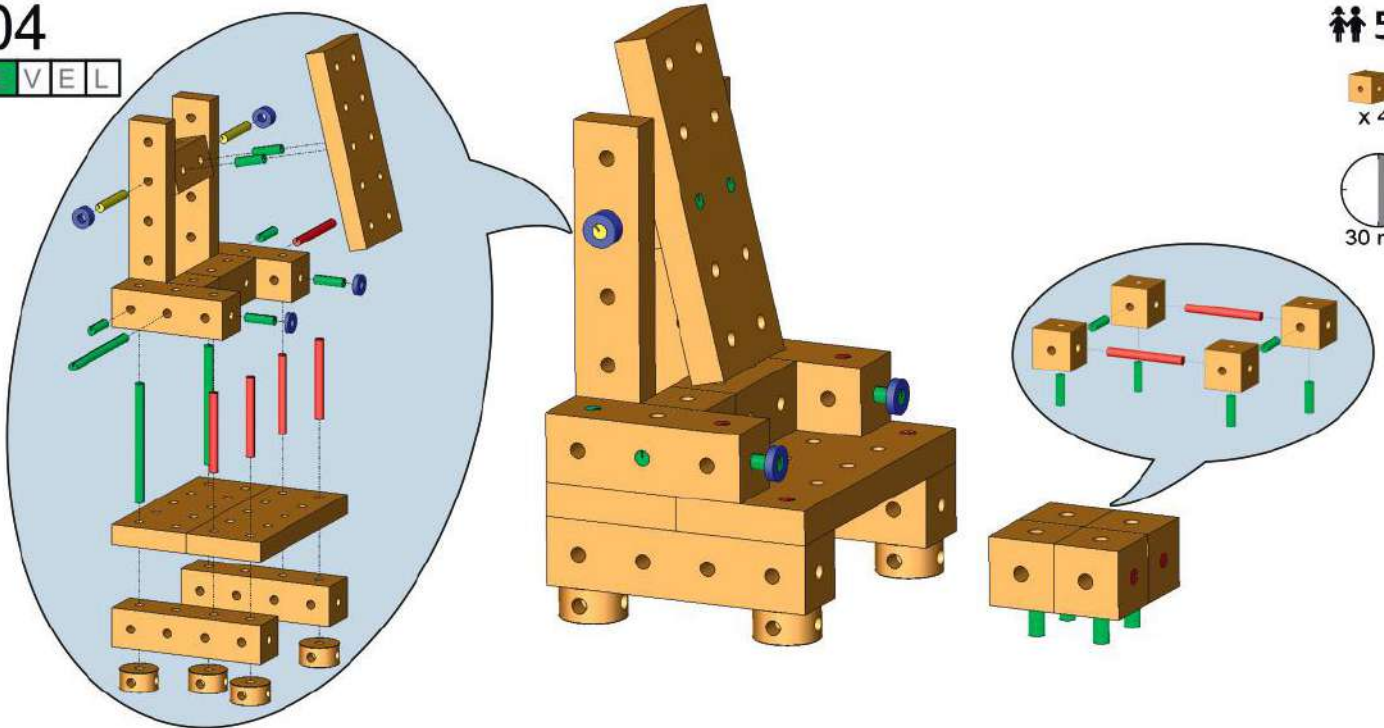

205

LEVEL

5+

x 80

40 min

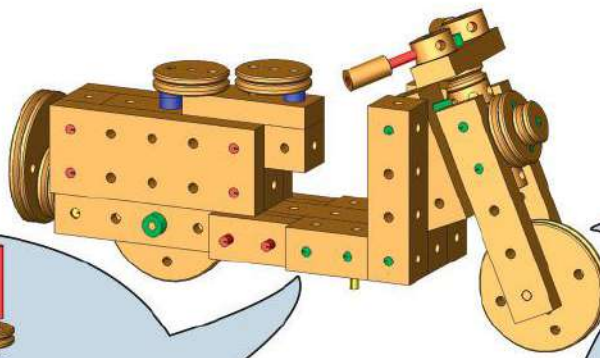
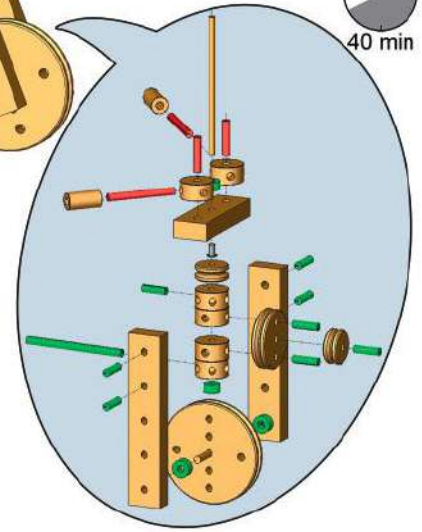
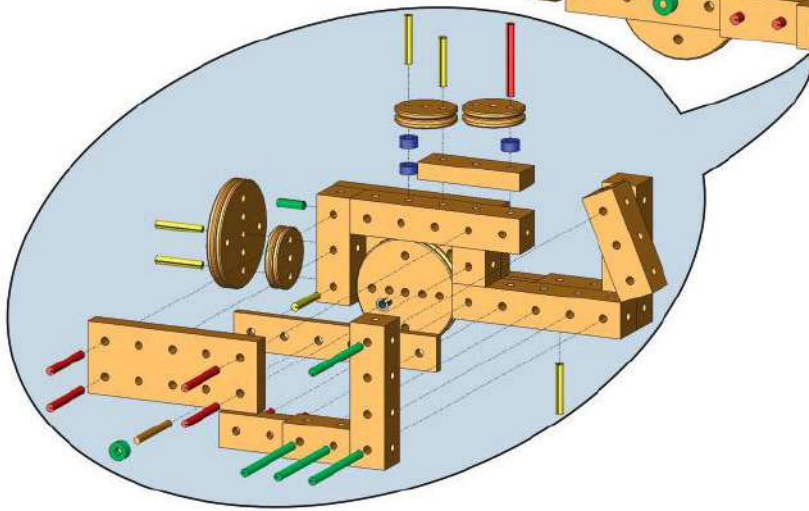

- | | | | | |
|----|----|----|----|--------------------|
| 1x | 2x | 4x | 9x | 6x |
| 2x | 2x | 2x | 2x | 3x |
| 2x | 2x | 2x | 6x | 2x |
| 2x | 2x | 4x | 9x | 1x $\frac{40mm}{}$ |
| 2x | 2x | 3x | 5x | 1x $\frac{80mm}{}$ |
| | | 2x | | |

206

LEVEL

5+

x 98

50 min

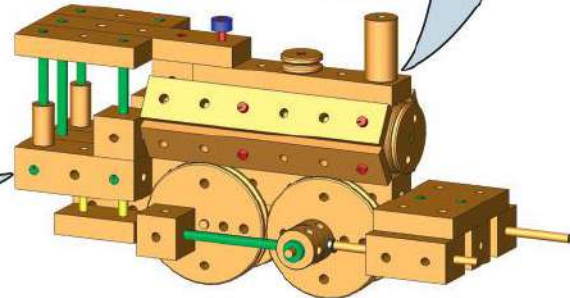
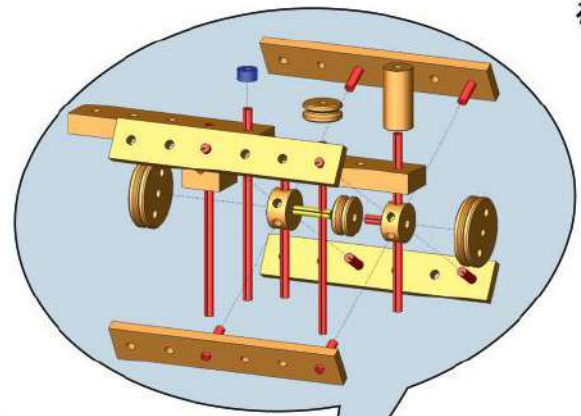
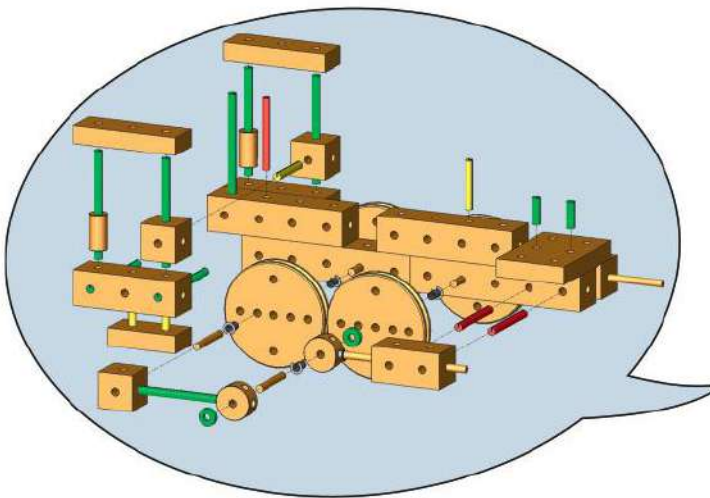

- | | | | | |
|----|----|----|-----|--------------------|
| 5x | 2x | 4x | 2x | 4x |
| 2x | 2x | 2x | 10x | 1x |
| 2x | 2x | 2x | 7x | 10x |
| 2x | 1x | 2x | 5x | 4x $\frac{30mm}{}$ |
| 2x | 4x | 4x | 7x | 2x $\frac{40mm}{}$ |
| | | 2x | 3x | 2x $\frac{80mm}{}$ |
| | | 1x | | |

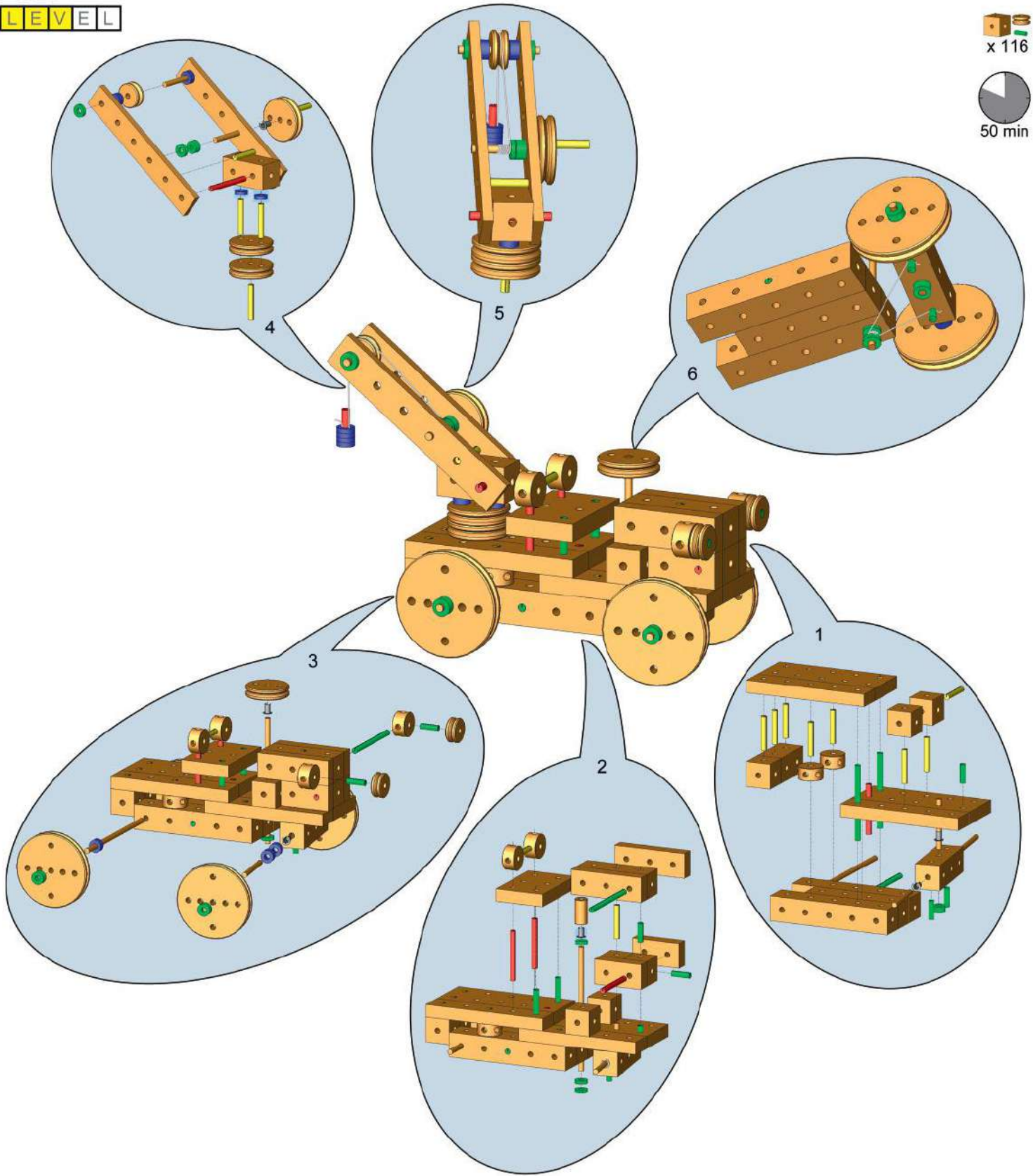

- | | | | | | |
|----|----|----|-----|-----|----|
| 5x | 2x | 4x | 7x | 6x | 5x |
| 2x | 2x | 2x | 1x | 6x | 2x |
| 2x | 2x | 3x | 16x | 10x | |
| 1x | 1x | 4x | 5x | 6x | |
| 2x | 2x | 4x | 4x | 6x | |
| | | 1x | | | |
| | | 1x | | | |

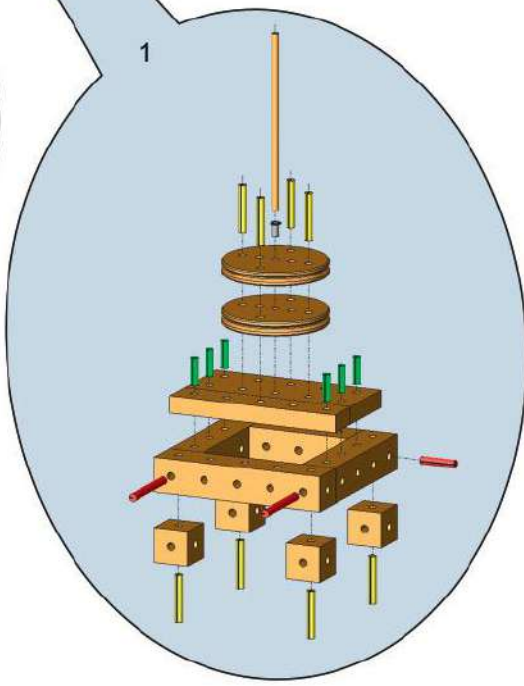
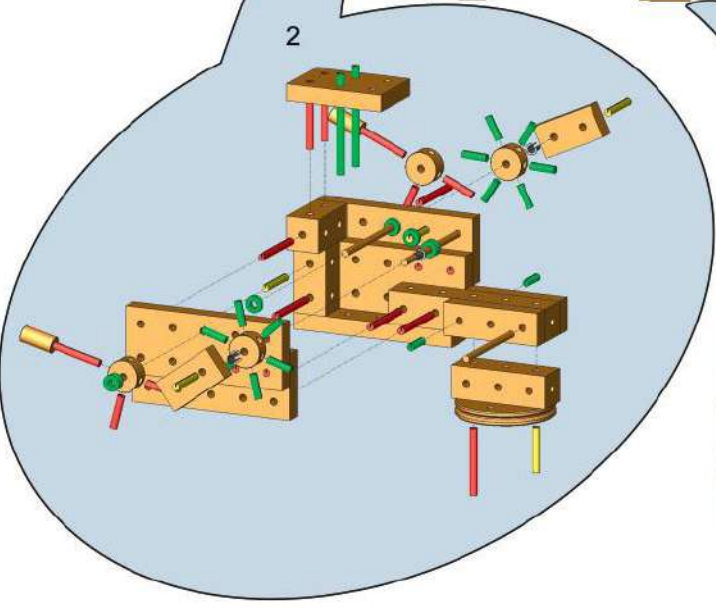
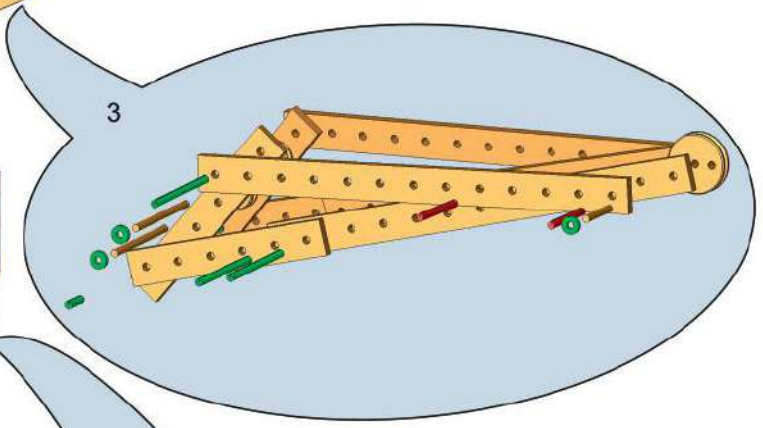
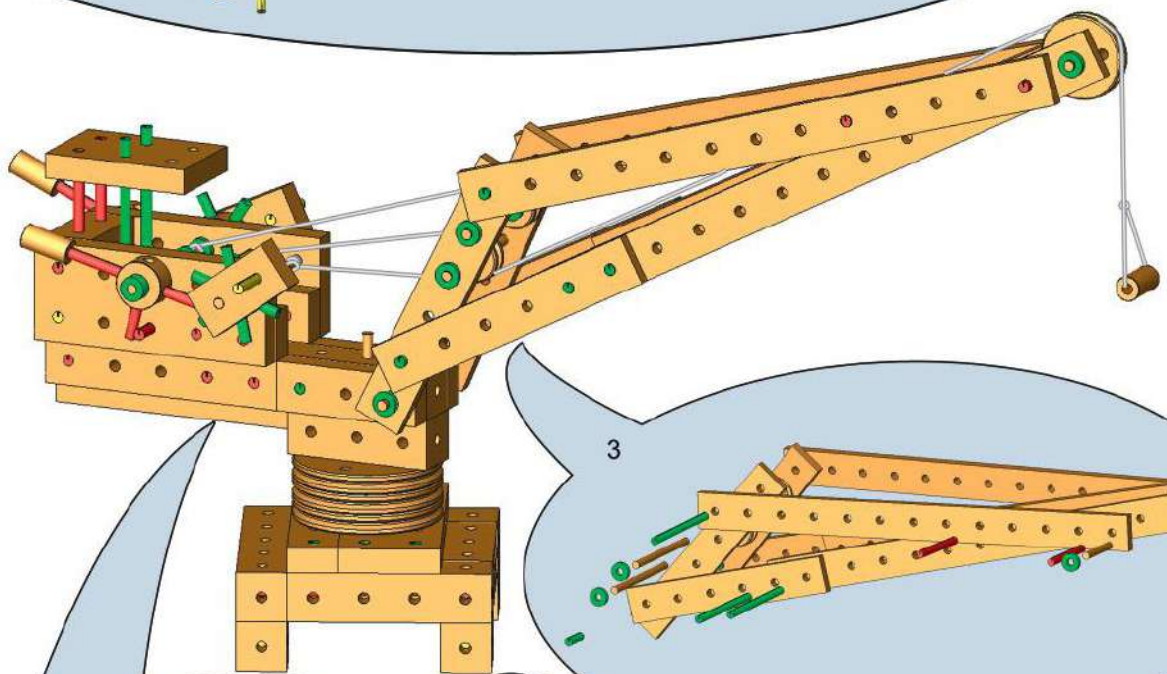
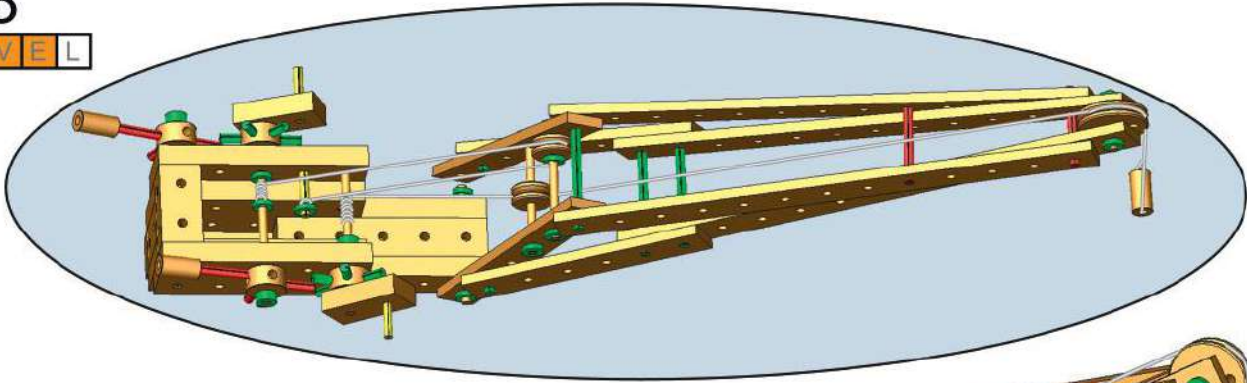

- | | | | | |
|----|----|----|-----|-----|
| 4x | 2x | 4x | 1x | 10x |
| 2x | 2x | 4x | 22x | 5x |
| 2x | 2x | 2x | 11x | 6x |
| 2x | 1x | 2x | 13x | 1x |
| 2x | 5x | 1x | 14x | 1x |
| 2x | 1x | 3x | 5x | 3x |
| | | 2x | | 1x |
| | | | | 2x |

